

**CALIFORNIA DEPARTMENT OF PUBLIC HEALTH
DIVISION OF DRINKING WATER AND
ENVIRONMENTAL MANAGEMENT**

**DRINKING WATER FIELD OPERATIONS BRANCH
SAN DIEGO DISTRICT**

CITY OF OCEANSIDE

**GAC FILTERS AT THE MISSION BASIN
DESALTING FACILITY AND WELL NO. 9**

WATER PERMIT NO. 05-14-09PA-010

System No.: 3710014

San Diego County

March 2009

Confidential

Pursuant to Government Code Section 6255, do not copy, distribute, release, or abstract any portion of this document without the written consent of the Chief of the Division of Drinking Water and Environmental Management.



State of California—Health and Human Services Agency
California Department of Public Health



MARK B HORTON, MD, MSPH
Director

ARNOLD SCHWARZENEGGER
Governor

March 23, 2009

Lonnie Thibodeaux
Water Utilities Director
City of Oceanside Water Utilities Department
300 North Coast Highway
Oceanside, CA 92054

Dear Mr. Thibodeaux:

**CITY OCEANSIDE WATER UTILITIES DEPARTMENT- SYSTEM NO. 3710014
PERMIT AMENDMENT NO. 05-14-09PA-010
GAC FILTERS AT THE MISSION BASIN DESALTING FACILITY AND WELL NO. 9**

The California Department of Public Health (CDPH) has issued an amended domestic water supply permit for City of Oceanside Water Utilities Department. The permit and engineering report are enclosed. Please advise CDPH in writing within 30 days if you do not agree to the permit or permit conditions.

If you have any questions regarding this letter, please contact William DiBiase or me at (619) 525-4159.

Sincerely,

Sean Sterchi, P.E.
District Engineer

Enclosure:

- (1) Water Supply Permit No. 05-14-09PA-010
- (2) Engineering Report

Certified

cc: Mark McPherson, Chief, Land and Water Quality Division, County of San Diego,
Department of Environmental Health (w / attachments)

STATE OF CALIFORNIA

AMENDMENT TO THE
DOMESTIC WATER SUPPLY PERMIT

ISSUED TO

City of Oceanside
System No. 3710014

ORIGINAL PERMIT NO.: 04-14-94P-009 DATE: October 7, 1994

PERMIT AMENDMENT NO.: 05-14-09PA-010 DATE: March 23, 2009

WHEREAS:

1. The City of Oceanside (City) submitted an application to the California Department of Public Health (CDPH) on July 28, 2008 for an amendment to the Domestic Water Supply Permit issued to the City on October 7, 1994.
2. The purpose of the amendment, as stated in the application, is to allow the City to make the following modifications to the public water system:
 - a. **Modify the Mission Basin Desalting Facility by adding granular activated carbon (GAC) filters for the control of 1,2,3-trichloropropane (TCP).**
 - b. **Add Well No. 09 as a raw water supply for the Mission Basin Desalting Facility.**
3. The City has submitted all of the supporting information required to evaluate the application.
4. CDPH has evaluated the application and the supporting material and has determined that the proposed modifications comply with all applicable State drinking water requirements.

THEREFORE:

CDPH hereby approves the application submitted by the City for a permit amendment. The Domestic Water Supply Permit issued to the City on October 7, 1994 is hereby amended to add Well No. 09 as a raw water source and a GAC filtration system to the **Mission Basin Desalting Facility** as an approved treatment for TCP control. This permit amendment is subject to the following conditions:

GENERAL PROVISIONS

1. The City shall comply with all the requirements set forth in the California Safe Drinking Water Act, California Health and Safety Code, and any regulations, standards or orders adopted there under.
2. The only sources approved for potable water supply are as follows:

Source	PS Code	Status	Capacity
<u>Raw Ground Water Sources:</u>			
Well No. 01	3710014-003	AR	750 gpm
Well No.02	3710014-004	AR	1,160 gpm
Well No.03	3710014-008	AR	~ 1,500 gpm
Well No.04	3710014-009	AR	~ 1,220 gpm
Well No.05	3710014-010	AR	~ 1,165 gpm
Well No.09	3710014-014	AR	~ 1,000 gpm
<u>Raw Surface Water Sources:</u>			
<u>Oceanside #2</u>	3710014-020	PR	30 cfs/ 13,465 gpm
<u>Oceanside #5</u>	3710014-021	PR	65 cfs/ 29,174 gpm
<u>Treated Water Sources:</u>			
R. Weese Filtration Plant	3710014-002	AT	25 MGD/ 17,361 gpm
Mission Basin Desalting Facility	3710014-006	AT	6.37 MGD/ 4,424 gpm
<u>Purchased Treated Sources:</u>			
SDCWA-TRTD-OC-3	3710014-007	PT	40 cfs/ 17,952 gpm
SDCWA-TRTD-OC-4	3710014-017	PT	20 cfs/ 8,977 gpm
SDCWA-TRTD-OC-6	3710014-018	PT	71 cfs/ 31,867 gpm
NCDP #1	3710014-019	PT	74.4 cfs/ 33,393 gpm

AR: Active Raw

AT: Active Treated

PT: Purchased Treated

PR: Purchased Raw

3. The approved treatment for the City includes the following treatment plants and treatment technologies:

Facility	PS Code	Treatment Technology	Treatment
Robert A. Weese SWTP	3710014-002	Direct Filtration	Surface Water
Mission Basin Desalting Facility	3710014-006	Reverse Osmosis, Fe/Mn pressure filters, GAC	TDS, Iron & Manganese, TCP

4. No changes, additions, or modifications shall be made to the sources or treatment mentioned in Permit Provisions (2) and (3) unless an amended water permit has first been obtained from CDPH.
5. All water supplied by the City for domestic purposes shall meet all Maximum Contaminant Levels (MCLs) established by CDPH. If the water quality does not comply with the Drinking Water Standards, treatment shall be provided.
6. Pursuant to Section 64700, Title 22, of the California Code of Regulations (CCR), no chemical or product shall be added to the drinking water as a part of the treatment process unless it has been certified as meeting the specifications of the National Sanitation Foundation/ American National Standards Institute (NSF/ANSI) Standard 60.
7. Pursuant to Section 64591, Title 22, of the CCR, a water system shall not use any chemical, material, lubricant, or product that may come into contact with the drinking water that has not been tested and certified as meeting the specifications of NSF/ANSI 61.
8. All persons responsible for the operation and maintenance of the water system shall be certified in accordance with Title 22, Sections 63750.1 through 64413.7, inclusive, of the CCR. In accordance with these requirements, the City shall employ operator(s) that hold the minimum distribution certification issued by the State of California, listed in the following table:

Water System Name	Distribution System Classification	Chief Distribution Operator Minimum Certification	Shift Distribution Operator Minimum Certification
City of Oceanside	D5	D5	D3

9. Pursuant to Sections 64413.1 and 64413.5, Title 22, of the CCR, each water treatment facility shall have a designated chief treatment plant operator and at least one shift treatment plant operator. In accordance with these requirements, the City shall employ operator(s) that hold the following minimum treatment certifications issued by the State of California to operate the treatment facilities listed in the following table:

Facility Name	Treatment Facility Classification	Chief Treatment Operator Minimum Certification	Shift Treatment Operator Minimum Certification
Robert A. Weese SWTP	T5	T5	T3
City of Oceanside Mission Basin Desalting Facility	T4	T4	T3

10. The City shall comply with Title 17 of the CCR to prevent the water system, sources, and treatment facilities from being contaminated from possible cross-connections. The City shall maintain a program for the protection of the domestic water system against backflow from premises having dual or unsafe water systems in accordance with Title 17 of the CCR. All backflow prevention devices shall be tested annually.

GROUNDWATER BACTERIOLOGICAL MONITORING

11. The City shall collect monthly raw water samples from all active groundwater wells operating during the month. These samples shall be analyzed for coliform bacteria. Bacteriological testing shall be performed using the density analytical method instead of presence absence.
12. All raw source water coliform samples collected at the groundwater wells shall be designated as "special" samples and will not be counted for compliance with the routine distribution system coliform monitoring requirements of the Total Coliform Rule.
13. All coliform-positive well water quality samples shall be analyzed for fecal coliform or E. coli bacteria.
14. The City shall submit the laboratory reports of raw water bacteriological analysis to CDPH by the tenth day of the following month.
15. The City shall notify CDPH within 24-hours if total coliform positive samples have been obtained from a well source and provide CDPH all follow-up sampling results.
16. Well sources that produce total coliform bacteria shall be removed from service following the collection of an additional raw water sample from the well. The raw water sample shall be analyzed for coliform and heterotrophic bacteria. If removal of the well from service may result in a water outage or failure of a drinking water standard, the City shall contact CDPH to discuss interim requirements for the use of this source.

17. Total coliform-positive wells that are removed from service shall be disinfected, pumped to waste until zero chlorine residual is obtained, and re-sampled after 24 hours for coliform and heterotrophic bacteria using the cycle test procedure. All re-samples should be negative for coliform and have a heterotrophic plate count (HPC) less than 500 colonies/mL prior to placing the source back into service.
18. Well sources removed from service for repair and/or maintenance activities shall be disinfected and tested for coliform and heterotrophic bacteria prior to placing them back into service. Well sources can not be placed back into service for the potable supply unless laboratory results show that the wells are coliform absent.

Well No. 9 Chemical Monitoring

19. The City must complete the required source water monitoring for general mineral, volatile organic chemicals (VOC), synthetic organic chemicals (SOC), inorganics, general physical, radioactivity, and unregulated chemicals in accordance with the vulnerability assessment and monitoring table contained in the enclosed Engineering Report, **Attachment No. 5**. The analysis shall be performed by a State certified laboratory and shall be submitted by Electronic Data Transfer (EDT). A complete list of the Primary Station (PS) Code numbers for the City sources is provided in the table in general provision #2. The PS code for Well No. 9 is: **3710014-014**
20. The City shall conduct the required source water monitoring per Title 22, sections 64431-64450, including conducting confirmation sampling and increased monitoring for newly detected contaminants. The City must complete the initial four quarters of monitoring for VOCs, SOCs and radiological parameters.
21. The City shall monitor for nitrate at least once per year at all wells. For those wells that exceed the trigger level of 23 mg/L as NO₃, the City shall initiate quarterly monitoring. The City shall monitor wells for nitrate per its approved treatment plant operations plan, if such plans specify more frequent monitoring.
22. The City shall monitor all approved sources in accordance with Chapter 15, Title 22, of the CCR.

GAC

23. The GAC treatment facilities shall be operated in accordance with an approved Operations Plan. This plan shall describe the operational and emergency procedures, monitoring program and reporting requirements. The City may modify the plan at any time to accommodate changing conditions; however, any modified plan must be submitted to and be approved by CDPH prior to implementation. At any time, CDPH can require the City to modify the plan due to changing conditions, change of laws or regulations, or concerns for public health.
24. The GAC facility's maximum design flow of 3,600 gallons per minute (gpm) shall not be exceeded.

25. Effluent from GAC facilities shall meet all Maximum Contaminant Levels and Action Levels established CDPH.
26. The City shall monitor TCP concentrations through each vessel such that the water system is able to anticipate the breakthrough of TCP in each GAC vessel, and shall arrange for timely and efficient change out of the spent GAC. The water system shall monitor according to the approved Operations Plan which shall include sample locations, frequencies, and set points that will trigger increased TCP monitoring and a GAC media change out.
27. The GAC contactors shall be maintained according to the manufacturer's specifications.
28. The City shall inspect the GAC vessels on a daily basis, and GAC operations records shall be maintained. Daily operations records shall include, at minimum, flow rate, total volume treated, chlorine residual measurements, and monthly bacteriological samples testing.
29. The City shall monitor the bacteriological quality of the treated water at the effluent of each GAC vessel prior to chlorination on a monthly basis, and prior to activating any vessel that has been out-of-service for more than 24 hours and following the installation of GAC media. The City shall have the samples analyzed for total coliform and heterotrophic plate count (HPC) bacteria. The City shall monitor according to the approved Operations Plan which shall include set points that will trigger GAC system maintenance.

DISINFECTION

30. The City shall maintain disinfection levels as described in the enclosed Engineering Report.
31. All treated water from the GAC filters shall be continuously and reliably chlorinated to a residual of at least 0.2 mg/L at all times. The chlorine residual shall be measured continuously at a sampling point located before the treated water reaches the first customer in the system.

RECORDS AND REPORTING

32. The City shall operate the GAC filters according to an approved Operations Plan. Any changes to the Operations Plan shall be submitted to CDPH for review and approval prior to implementation. The City shall update its Operations Plan to include the recent GAC filter addition, and submit the revised Operations Plan to CDPH for review within 60 days of issuance of this permit amendment.
33. The City shall keep a complete record of any emergency and scheduled interruptions in water service. These records should include:
 - a. Location of the problem.

- b. Cause of the interruption.
- c. Date and approximate time of the problem.
- d. Precautions taken to minimize contamination of the supply and notification of affected users.
- e. Resolution of the interruption.

34. The City shall submit a monthly operation report and copies of any water quality test results to CDPH by the tenth day of the following month. The monthly report shall follow the template contained in the approved Operations Plan.

- a. For the GAC vessels, the report shall include, at a minimum, flow rates, total volume treated during the month, bed volumes treated since the last carbon change-out, and a summary of the TCP and bacteriological monitoring.

35. The City shall record the water production output on a monthly basis. Written water production records shall be maintained by the City for a minimum of ten years and be available to CDPH during inspections.

36. All water samples for compliance purposes shall be analyzed by a laboratory certified by CDPH's Environmental Laboratory Accreditation Program (ELAP) for each analytical method.

37. All water quality monitoring results analyzed by a certified laboratory shall be submitted to CDPH by Electronic Data Transfer (EDT) using the assigned Primary Station Code (PS Code) of the monitoring site. Bacteriological monitoring results shall be submitted by hard copy to CDPH unless otherwise directed.

This permit amendment shall be appended to and shall be considered to be an integral part of the Domestic Water Supply Permit (04-14-94P-009) issued to the City on October 7, 1994.

FOR THE CALIFORNIA DEPARTMENT OF PUBLIC HEALTH

3/23/09
Date

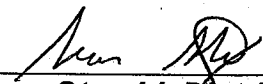
Sean Sterchi, District Engineer

**Engineering Report
For Consideration of the Permit Amendment Application From
City of Oceanside
SAN DIEGO COUNTY**

**California Department of Public Health
Drinking Water Field Operations Branch
San Diego District**

**System No. 3710014
March 2009**

Report Prepared By: _____

William DiBiase
Sanitary Engineer

Report Reviewed By: _____

Sean Sterchi, P.E.
District Engineer

TABLE OF CONTENTS

I	INTRODUCTION.....	1
1.1	Purpose of Report.....	1
1.2	Background Information.....	1
1.3	Description of the Project.....	2
1.4	Facilities.....	2
1.5	Sources of Information.....	3
II	INVESTIGATION AND FINDINGS	3
2.1	Sources of Supply.....	3
2.2	Source Water Quality.....	4
2.3	Source Water Assessment	5
2.4	Groundwater Monitoring	5
2.5	Treatment.....	5
2.5.1	Mission Basin Desalting Facility	5
2.5.2	Pureflow Package Iron and Manganese Pressure Filter	5
2.5.3	GAC Treatment	6
2.5.4	Disinfection.....	9
2.5.5	Treatment Classification.....	9
2.6	Operation and Maintenance	9
2.6.1	Organization and Personnel.....	9
2.6.2	Operations Controls	10
2.6.3	Treatment Process Monitoring	11
2.7	California Environmental Quality Act (CEQA).....	11
III	APPRAISAL OF SANITARY HAZARDS AND PUBLIC HEALTH SAFEGUARDS...	12
IV	CONCLUSIONS AND RECOMMENDATIONS.....	12
V	APPENDICES	19

I INTRODUCTION

1.1 PURPOSE OF REPORT

By application dated July 28, 2008 (**Attachment No.1**), the City of Oceanside (hereinafter "City") applied for a permit amendment to add Granular Activated Carbon (GAC) filters for the control of 1,2,3-trichloropropane (TCP), and an additional water source identified as Well No. 9 to the Mission Basin Desalting Facility (MBDF). The City currently operates under domestic water supply permit No. 04-14-00PA-000 granted by the State Department of Public Health (CDPH) in September 2000. CDPH last conducted a system-wide sanitary survey in 2002. The purpose of this report is to document the sanitary engineering review of the facilities and operation, and to make recommendations regarding issuance of an amended domestic water supply permit.

1.2 BACKGROUND INFORMATION

As of March 2008, the City serves a year-round population of 177,000 people via 42,764 metered service connections. The water system is served by three sources; the San Diego County Water Authority (SDCWA) treated surface water, treated surface water from the City's Weese treatment plant, and treated groundwater from the City's MBDF (reverse osmosis treatment plant). Twelve concrete and welded steel reservoirs provide 50.5 million gallons (MG) of gravity storage for the sixteen pressure zone system.

Table 1 - Water Usage for the Past Four Years:

Year and Source	Daily Max	Monthly Max / Month	Annual Total
2007 Groundwater Produced	2.33 MG	71.3 MG / March	755.5 MG
2007 Surface Water Purchased	32.5 MG	899.4 MG / August	9,136.5 MG
2006 Groundwater Produced	3.25 MG	73.8 MG / March	695 MG
2006 Surface Water Purchased	44.5 MG	1,218 MG / July	10,484 MG
2005 Groundwater Produced	3/5/05	82.2 MG / August	683.4 MG
2005 Surface Water Purchased	8/26/05	1,156.5 MG / July	10,197.9 MG
2004 Groundwater Produced	3.1 MG	92.9 MG / March	874.4 MG
2004 Surface Water Purchased	48.3 MG	1,230.8 MG	10,581.4 MG

The City's five permitted groundwater wells pump water from the Mission Groundwater Basin in the lower San Luis Rey River watershed. The groundwater wells provide an important local source of supply that is not dependent upon imported water. After the discovery of TCP in some of the wells the City elected to install GAC filters.

1.3 DESCRIPTION OF THE PROJECT

The City owns and operates the 6.37 MGD MBDF, which treats brackish groundwater from five existing supply wells. Three of the five existing groundwater supply wells (Wells No.1,2,3), in addition to the new well (no. 9), contain 1, 2, 3 - trichloropropane (TCP) at concentrations in excess of the 5 ng/L California Department of Public Health (CDPH) Notification Level.

The reverse osmosis membranes currently used at the MBDF have shown that they can reject approximately 60 to 70 percent of TCP. However, the product water after RO treatment and blending still has concentrations ranging from 35 to 65 ng/L.

After bench and pilot scale testing, the City demonstrated that granular activated carbon (GAC) is an effective treatment technology to reduce TCP from the RO permeate to concentrations below 5 ng/L.

With the addition of a new 3,600 gpm GAC treatment system to the MBDF, the City will be able to treat source water containing TCP. Therefore, the City will bring a new well (No. 9) online, further utilizing the Mission Groundwater Basin as a water source.

1.4 FACILITIES

The 3,600 gpm GAC system will be added to the MBDF downstream of the RO process to remove TCP from all of the RO permeate to concentrations less than 5 ng/L. The system will be comprised of five GAC pressure contactors; four of the contactors will operate in parallel, with the fifth serving as a rotating lag vessel. The system is located at the MBDF site, directly north of the RO building. Groundwater from Wells 4 and 5 that does not contain 123-TCP by-passes the RO and GAC systems and is blended with the GAC treated water prior to distribution. The MBDF and Well No. 9 were inspected in January 2009.

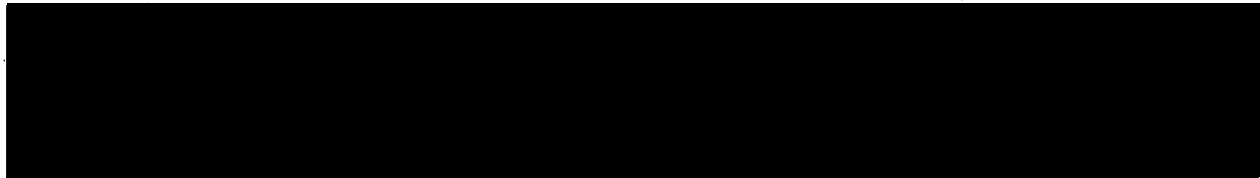

Well No. 9 was developed to increase the supply of raw feed water for the MBDF. With this additional well, the total source capacity for the facility will be 6,795 gpm (over 1.5 times the current treatment capacity). However, due to the hydrogeology of the basin, wells in close proximity are usually not operated at full capacity to minimize large water level draw-downs. The groundwater is transmitted via a 16-inch dedicated raw groundwater pipeline to the plant. A well site plan is included in **Attachment No. 2**. An inspection of Well No. 9 was conducted in January, 2009.

1.5 SOURCES OF INFORMATION

Information for this report was obtained from the following sources:

- Malcolm Pirnie. *GAC Engineering Report*. City of Oceanside, September 2008
- Siemens Water Technologies. *Operation & Maintenance Manual for HP-1220ST-125 GAC Adsorption System*. City of Oceanside, August 2008.
- Guss Pennell, Environmental/Regulatory Compliance Officer, City of Oceanside.
- Jason Dafforn, Project Manager, City of Oceanside.
- System files, and the technical specifications and plans submitted by the City.
- Tetra Tech/San Diego County Water Authority. *Test Well D/TW1/PW9 Results of Drilling, Construction, Development and Testing*. May 2004.
- The Annual Report to the Drinking Water Program. 2003-2007.
- Water Permit No. 04-14-94P-009. June 1994
- Water Permit No. 04-14-00PA-000. September 2000
- Site visit on January 21, 2009.

II INVESTIGATION AND FINDINGS

2.1 SOURCES OF SUPPLY

The source of supply for the GAC filters is the RO effluent from the MBDF. The source of supply for the MBDF RO treatment is groundwater extracted from the Mission Groundwater Basin from Wells No. 1, 2, 3, and new Well No. 9. The source of supply for the bypass flow (and iron and manganese pressure filter treatment) is groundwater from Wells No. 4 and 5. Table 2 lists all active MBDF wells and capacities.

Table 2- Well Capacities

Well No.	Yield (gpm)
1	750
2	1,160
3	Estimated at 1,500
4	Estimated at 1,220
5	Estimated at 1,165
9	Estimated at 1,000

sedimentary bedrock. Well No. 9 is equipped with a 100-HP 3-stage vertical turbine pump capable of producing 2,000 gpm. The well is equipped with the necessary appurtenances such as a casing vent, air/vacuum relief valve, sampling tap, meter, etc.

A dedicated waste line is provided for automatic discharge to a storm drain upon start-up. An adequate air gap is provided. Key well parameters are outlined in Table 3 below.

Table 3– Well Construction Summary

	Well No. 9
Well Depth (ft bgs)	240
Well Capacity (gpm)	2,000
Sanitary Seal Depth	50
Gravel Pack (Y/N)	Yes
Perforations (ft bgs)	100-220
Casing Diameter	16
Pump-to-Waste Disch.	Yes
Pump Type	Submersible
Motor HP	100
Pump Setting Depth	80 ft bgs
Lubrication	Water
Power	Electric
Auxiliary Power	Diesel emergency backup generator
Disinfection Facilities	Disinfection is provided at the MBDF
Sample Tap Location	At the Well Head
Water Quality Issues	TDS (~1,500 mg/l); Iron (~2,300); Manganese (~460) 123-TCP (~190ng/L)
Meets Construct. Stds.	Yes
Meets Min. Separation	Yes
Notes	

Site plans of Well No. 9 and the GAC system are included as **Attachment No. 2**. More detail for Well No. 9 is provided on the Well Datasheets included as **Attachment No. 3**

2.2 SOURCE WATER QUALITY

Title 22 water quality analysis was performed on samples collected at Well No. 9 in February 2004 and October 2008. The 2008 initial chemical water quality testing results for Well No. 9 are summarized in the tables provided as **Attachment No. 4**. In the 2004 analysis, the laboratory reported a total dissolved solids (TDS) value of 1,500 milligrams per liter (mg/L), a chloride value of 510 mg/L, and a sulfate value of 440 mg/L. These concentrations are above the CDPH recommended drinking water standard of 500 mg/L for TDS, and 250 mg/L for chloride and sulfate. Dichloropropane is present at 1.2 µg/L (above the trigger of 0.5 µg/L but below the MCL of 5 µg/L). The organic compound 1,2,3-Trichloropropane (1,2,3-TCP) was detected at a concentration of 190 nanograms per liter (ng/L). Constituents reported above their trigger threshold are summarized in Table 4.

Table 4 - Well No. 9 Water Quality Summary

Constituent	Sample Date	Result	Units	MCL	DLR	Trigger
Secondary DW Standard: Chloride	08/19/2005	510	mg/L	600	---	500
Regulated VOC:1,2-Dichloropropane	08/19/2005	1.2	µg/L	5	0.5	0.5
1,2-Dichloropropane	10/09/2008	1.3	µg/L	5	0.5	0.5
State UCMR: 1,2,3-Trichloropropane	08/19/2005	0.15	µg/L	---	0.005	0.005
1,2,3-Trichloropropane	08/19/2005	0.14	µg/L	---	0.005	0.005

2.3 SOURCE WATER ASSESSMENT

The City completed the Drinking Water Source Assessment for Well No. 9 in November 2004. The most highly ranked possible contaminating activities that were identified are: sewer collection systems, agricultural/ irrigation wells, petroleum pipeline, dry cleaners, gas stations, automobile repair facilities, car washes, parking lots/malls, hardware/ lumber/ parts stores, drinking water treatment plants, high density housing, above ground storage tanks, water supply wells, and state highways.

2.4 GROUNDWATER MONITORING

The City must monitor Well No. 9 in accordance with an approved monitoring plan required per Title 22, Section 64416. The City must complete the initial 4-quarters of monitoring for volatile organic chemicals (VOCs), synthetic organic chemicals (SOCs), and radiological parameters. The minimum monitoring requirements, after completion of initial monitoring, are included in **Attachment No. 5**.

2.5 TREATMENT

2.5.1 MISSION BASIN DESALTING FACILITY

The existing groundwater treatment at the MBDF is comprised of pretreatment, cartridge filtration, reverse osmosis membrane treatment, decarbonation, and chloramination. The RO membrane system is designed as a two-pass system with a 75% overall recovery rate. The overall capacity of the MBDF is 6.37 MGD. The RO units can produce approximately 4.3 MGD of permeate which is blended inline with approximately 2.0 (max 2.9) MGD of bypass groundwater just upstream of the decarbonators. Disinfection of the product water is applied in the transmission pipeline between the decarbonator and the discharge pump forebay to achieve a 2.3 mg/L chloramine residual. A detailed description of the RO treatment process for the MBDF is included in the June 1994 Permit Engineering Report for the system. A process schematic of the MBDF is included as **Attachment No. 6**

2.5.2 PUREFLOW PACKAGE IRON AND MANGANESE PRESSURE FILTER

A 100 MGD Pureflow package iron and manganese (Fe/Mn) pressure filter pilot plant was installed in December 1999 to treat a portion of the raw blend water, which has high concentrations of iron and manganese. This raw water does not pass through either the RO system or the new GAC system; therefore it will only be fed by the two source wells that do not contain 123-TCP (Wells No. 4 and 5). A detailed description of

the Fe/Mn treatment process is included in the September 2000 Permit Engineering Report for the system.

2.5.3 GAC TREATMENT

A GAC system was added to the MBDF downstream of the RO process to remove TCP to concentrations less than 5 ng/L in the RO permeate. Permeate water from the RO filters is routed to the influent manifold of the GAC vessels via an 18-inch pipe. The system consists of five GAC contactors. The design capacity for each contactor is 900 gpm to achieve an empty bed contact time (EBCT) of 5.9 minutes. With 4 contactors operating in parallel, the total capacity of the GAC system is 3,600 gpm. The GAC system will be operated to treat approximately 100 percent of the MBDF RO permeate flow and has been designed to accommodate additional GAC contactors if necessary in the future.

Each contactor is 144 inches in diameter, approximately 17 feet tall, and contains 20,000 lbs. of GAC. The current carbon supplied by US Filter is NSF 61 certified with an effective size of 0.60 – 0.85 mm, uniformity coefficient of 2.00 and iodine number of 1,100. The GAC used will be pre-washed. The contactor vessel is constructed of carbon steel and has a maximum working pressure of 125 psi at 150 °F. The basic GAC design parameters are summarized in Table 5 and the GAC process flow diagram is included in **Attachment No. 7**.

Table 5 – GAC Design Parameters

Parameter	Value
GAC System Provider	Siemens Water Technologies Corp.
Number of GAC vessels	4 operating + 1 standby
Vessel Diameter (ft)	12
Carbon Capacity (lbs)	20,000
Vessel Volume (gal)	7,650 7,520
Carbon Bed Volume (ft ³)	714
Bed Depth (ft)	5
Contactor Configuration	Staggered parallel operation with a rotating standby contactor
Design Flow Rate (gpm)	900 gpm per vessel
Flow Direction	Down-flow
Maximum Operating Pressure (psi)	125psi @ 150°F
Design empty bed contact time	5.9 minutes @ 900 GPM
Total GAC Vessel Flow (gpm)	900 ave. 1,100 max.
Hydraulic loading rate	8.1 gpm/sf
Backwash Flow Rate (gpm)	900 -1,000
Backwash Duration (min)	15
Carbon Type	Coconut shell based

As the water flows through the GAC, organic contaminants including TCP are removed by adsorption onto the surface and pores of the GAC particles. This creates a mass transfer zone in the GAC vessel, which moves downward through the vessel as more water is treated. Eventually, all the adsorption sites on the GAC bed are filled and the GAC bed is considered exhausted.

The GAC filter vessels at the MBDF have sampling ports that allow testing and monitoring of the bed at 0% (0 min. EBCT, i.e., contactor influent), 25% (1.475 min. EBCT), 50% (2.95 min. EBCT), 75% (4.425 min. EBCT), and 100% (5.9 min. EBCT, i.e., contactor effluent). These ports will allow operators to track the progress of the mass transfer zone and predict bed exhaustion.

Once the GAC system is started and in normal operation mode, the GAC for any contactor will be completely replaced at the point at which TCP is detected at the 4.425 min. EBCT sample point. i.e. 75 percent of the full EBCT. Therefore, 25 percent of the GAC bed in each contactor will serve as a buffer to ensure that TCP breakthrough does not occur. The City must regularly test all contactors for TCP at the 75% sample port. The minimum required monitoring requirements shall be summarized in a revised MBDF Operations Plan and submitted for CDPH review.

2.5.3.1 GAC

The GAC used will initially be Westates AquaCarb 1230C virgin coconut shell manufactured by US Filter. The replacement carbon will be NSF/ANSI Standard 61 certified virgin coconut GAC approved for drinking water treatment. The City's specifications for GAC are summarized in Table 6:

Table 6 – GAC specifications

Mesh Size	12 x 40
Screen Analysis	
Retained on top screen (maximum)	10%
Retained on bottom screen (maximum)	5%
Effective size, mm	0.6 to 0.85
Uniformity Coefficient (maximum)	2.0
Iodine Number mg I ₂ /g (minimum)	1050
Hardness Number	97
Abrasion Number	85
Apparent Density, g/cc	0.47-0.52
Total Ash (maximum percent)	5
Moisture, as packed (maximum percent)	5

2.5.3.2 CARBON CHANGE-OUT

When TCP is detected at any concentration at the 75% sample port in any contactor, the carbon in that contactor will be replaced. Prior to taking the exhausted contactor off-line, one of two options will be followed. The first option is to reduce the feedwater flowrate to a maximum of 2,700 gpm to limit the flow through each of the three remaining on-line vessels to 900 gpm each. The second option is to bring the fifth vessel on line and continue operating at 3,600 gpm. This will allow the system to be in constant operation.

After City operations personnel isolate the exhausted GAC vessel, the carbon bed replacement procedures will be initiated and conducted by a certified carbon supplier

representative. The contactor vessel will be pressurized up to 30 psig with air. With the addition of utility water, the spent carbon will be pneumatically displaced as slurry into a transport trailer. Approximately 9,000 gallons of water is required to keep the 20,000 pounds of spent GAC in slurry. The spent GAC will be dewatered onsite and sent off-site.

To refill the GAC vessel, the fresh carbon in the trailer is slurried using clean water, pressurized up to 15 psig, and then transferred into the empty GAC vessel. After installation of new carbon, the carbon should be soaked for 24 hours with GAC-treated water, then backwashed to waste before start-up.

2.5.3.3 BACKWASH

Individual GAC vessels are to be backwashed prior to starting up the GAC system and whenever pressure loss builds up during normal operation of the GAC system. Only one GAC contactor should be backwashed at a time. Backwashing will remove carbon fines and entrapped air, and fully stratify the carbon bed, reducing the potential for short-circuiting. Backwashing can also be used to remove surface deposits on the GAC to reduce the pressure drop across the vessel.

According to the Operating Manual, the backwash flow rate required is 900 gpm, and the duration is approximately 15 minutes or until the water leaving the contactor is clear. If the water temperature falls below 55°F, the backwash flow should be lowered to avoid washing out carbon. The backwash operations will use a separate source of potable water.

Rinsing, using process water (RO permeate), is also required following a backwash. Each vessel is rinsed at 900 gpm for approximately 5 minutes.

The spent backwash water is discharged to the Waste Backwash Water Sump that is shared by the RO and Fe/Mn treatment systems. The Waste Backwash Water Sump is discharged via pumping to the sanitary sewer.

2.5.3.4 START-UP

Backwashing of GAC vessels (see section 2.3.3.3) is required prior to starting up the GAC system. Rinsing of GAC vessels using RO permeate process water is required following backwashing.

Start-up procedures and steps will be performed in accordance with a CDPH approved Operations Plan.

At initial system start-up, each of the five vessels will be filled with GAC to the following percent capacity in order to stagger operation:

Vessel 1:	50%
Vessel 2:	50% full
Vessel 3:	75% full
Vessel 4:	100% full
Vessel 5:	Empty

When TCP is detected at the 75% port in Vessel 1, Vessel 5 will be filled to 100% full with GAC and brought on line, while Vessel 1 is taken out of service for full GAC removal. Vessel 1 will now serve as the stand-by unit for an additional time period equal to half of the original detection period for Vessel 1. After this time, Vessel 1 will be filled to 100% and brought on line while Vessel 2 is taken out of service for GAC removal and stand-by duty. Upon detection of TCP at the 75% port in Vessel 3, Vessel 2 will be filled and brought on line while Vessel 3 is taken out of service for GAC removal and stand-by duty. At this time, all vessels will be loaded to full 100% GAC capacity and will be changed out upon TCP detection in the 75% port. The remaining 25% of the GAC bed will serve as a buffer to ensure that TCP breakthrough never occurs.

2.5.4 DISINFECTION

Disinfection of the MBDF product water is achieved through chloramination. Sodium hypochlorite is injected at an average concentration of 2.8 mg/L into the product water line after the decarbonator clearwell, followed by application of aqua ammonia (1 mg/L) and sodium hydroxide (if necessary for pH adjustment). The total chlorine residual of the MBDF product water averages 2.8 mg/L, with free chlorine residual at 0.2 mg/L. The dosage applied at the Desalting Facility is controlled by the process computer to maintain a residual of 2.8 – 2.9 mg/L at the Talamantes reservoir. There are no potable water service connections prior to this reservoir.

2.5.5 TREATMENT CLASSIFICATION

Pursuant to Title 22, Section 64413.1 of the Operator Certification Regulations, CDPH classifies the MBDF as a T4 facility.

Per Section 64413.5, the City will be required to designate at least one certified T4 chief operator and one certified T3 shift operator for the MBDF. All chief and shift operators must possess valid operator certifications per Section 63765.

2.6 OPERATION AND MAINTENANCE

2.6.1 ORGANIZATION AND PERSONNEL

The MBDF operators will operate the GAC system. The names and certificates of the operators are listed in Table 7.

Table 7 – Operating Personnel at the Mission Basin Desalting Facility

Name	Certificate Grade	Certificate No.	Renewal Date	Work Phone Numbers
T. Scott Tucker	T4	10774	3-1-2011	760-435-5920
Kerry D. Singleton	T4	12706	1-1-2011	760-435-5920
Michael P. Flaherty	T3	20469	1-1-2010	760-435-5920
Tom L. Weld	T3	16850	5-1-2010	760-435-5920
Richard C. Browning	T3	23628	2-1-2011	760-435-5920
Ralph M. Felix	T4	15961	1-1-2010	760-435-5920
Kristen R. Martinez	T3	25466	7-1-2010	760-435-5920
Bruce M. McCarter	T4	21643	6-1-2010	760-435-5920
Donald G. Keifer	T2	23671	5-1-2010	760-435-5920

2.6.2 OPERATIONS CONTROLS

The GAC system valves are mostly operated manually. 8-inch butterfly valves with manual actuators are used on each vessel for the vessel influent, vessel effluent, backwash supply, and backwash return lines. These valves open or close to allow flow, or to isolate the associated vessel. The 8-inch potable water backwash line also uses two similar manually actuated butterfly valves for influent and effluent control.

Each of the five vessels is equipped with a modulating valve and a flow meter to control and monitor the effluent from each vessel. Each valve can be set to either Manual or Auto mode via the Operator Interface Terminal (OIT). In Manual mode, the position (0-100% open) of the valve can be adjusted via the OIT. In Auto mode, the valve is modulated based on feedback from the corresponding flow meter to achieve the desired flowrate.

Each vessel is equipped with a 2" ball valve for venting the vessel, a 2" ball valve for flooding and wash down, and a 1" ball valve on the GAC vessel air release vent that is closed during slurry removal.

Table 8 lists the GAC system valve details. See **Attachment No. 7** for the GAC Process Flow Diagram showing where these valves are located.

Table 8 GAC System Valve Details

Valve No.	Valve Type	Valve Location	Valve Function
V1A-E	8" butterfly valve with manual actuator	On 8" GAC vessel influent line	Opens/closes for flow to, or isolation of associated vessel; Open for normal operation.
V2A-E	8" butterfly valve with manual actuator	On 8" GAC vessel backwash supply	Open for backwash flow to associated vessel; Closed for normal operation.
V3A-E	8" butterfly valve with manual actuator	On 8" GAC vessel backwash return	Open for backwash flow from associated vessel; Closed for normal operation.
V4A-E	8" butterfly valve with manual actuator	On 8" GAC vessel effluent line	Opens/closes for flow from, or isolation of associated vessel; Open for normal operation.
V5A-E	8" butterfly valve with auto control actuator	On 8" GAC vessel effluent line	Opens/closes to balance flow from associated vessel; Control actuated for normal operation.
V6A-E	2" ball valve	At bottom end of 2" GAC vessel utility/vent line.	Opens to vent from associated vessel; Closed for normal operation.
V7A-E	2" ball valve	On 2" GAC vessel utility/vent line with quick connector	Opens to flood associated vessel and wash down; Closed for normal operation
V8A-E	1" ball valve	On 1" GAC vessel air release vent line.	Open to vent associated vessel; Close to slurry carbon out. Open for normal operation.
V9	8" butterfly valve with manual actuator	On 8" potable water backwash influent line	Opens/closes for backwash; Closed for normal operation.
V10	8" butterfly valve with manual actuator	On 8" potable water backwash effluent line	Opens/closes for backwash; Closed for normal operation.

2.6.3 TREATMENT PROCESS MONITORING

City operators at the MBDF will be responsible for TCP and Bacteriological testing at each of the operational GAC vessels. A monitoring plan describing sample locations, frequency, and trigger points will be included in a CDPH approved Operations Plan.

2.7 CALIFORNIA ENVIRONMENTAL QUALITY ACT (CEQA)

The California Department of Public Health (CDPH) as Responsible agency pursuant to CEQA (California Environmental Quality Act) has reviewed the Worksheet for CEQA Exemptions prepared by the City of Oceanside on August 21, 2008. CDPH found that the project did not require further environmental review. The City of Oceanside filed a Notice of Exemption through the County Clerks Office on August 19, 2008.

As Responsible agency, CDPH has considered the Worksheet and project description and hereby makes the following findings for permit amendment:

The project is exempt from CEQA under CCR, Title 14

- Class 1 (CCR, Title 14, Sec 15301 and Title 22, Section 60101 (a))

A copy of the Department's Notice of Exemption (NOE) is included as **Attachment No. 8**. The Department's NOE will be filed with the Governor's Office of Planning and Research within five days after issuance of the permit amendment.

III APPRAISAL OF SANITARY HAZARDS AND PUBLIC HEALTH SAFEGUARDS

The City is capable of providing an adequate supply of safe, wholesome, and potable water to the City's customers when operating the GAC vessels.

The City must monitor the mass transfer zones in the GAC vessels. Each vessel is equipped with five sampling ports. The City must regularly monitor to determine when to change out the GAC in the vessels.

The City must include a GAC treatment process monitoring program in its Operations Plan and submit it to CDPH for review. CDPH recommends that the samplers take note of both the vessel and sample port number to help reconcile the monitoring data with operations records.

The stored backwash water can be discharged to the Waste Backwash Water Sump that is shared by the RO and Fe/Mn treatment systems. The Waste Backwash Water Sump is discharged via pumping to the sanitary sewer.

IV CONCLUSIONS AND RECOMMENDATIONS

The California Department of Public Health, Division of Drinking Water and Environmental Management, Drinking Water Field Operations Branch finds that the sources, works, and operation as described in this report are capable of providing a safe, wholesome and potable water supply. It is anticipated that the quality of water delivered will meet all applicable State Drinking Water Standards. Issuance of an amended domestic water supply permit by the California Department of Public Health to the City to (1) add Well No. 9, and (2) to operate the 3,600 gpm GAC treatment system, is recommended subject to the following provisions:

GENERAL PROVISIONS

1. The City shall comply with all the requirements set forth in the California Safe Drinking Water Act, California Health and Safety Code, and any regulations, standards or orders adopted there under.
2. The only sources approved for potable water supply are as follows:

Source	PS Code	Status	Capacity
<u>Raw Ground Water Sources:</u>			
Well No. 01	3710014-003	AR	750 gpm
Well No.02	3710014-004	AR	1,160 gpm
Well No.03	3710014-008	AR	~ 1,500 gpm
Well No.04	3710014-009	AR	~ 1,220 gpm
Well No.05	3710014-010	AR	~ 1,165 gpm
Well No.09	3710014-014	AR	~ 1,000 gpm
<u>Raw Surface Water Sources:</u>			
<u>Oceanside #2</u>	3710014-020	PR	30 cfs/ 13,465 gpm
<u>Oceanside #5</u>	3710014-021	PR	65 cfs/ 29,174 gpm
<u>Treated Water Sources:</u>			
R. Weese Filtration Plant	3710014-002	AT	25 MGD/ 17,361 gpm
Mission Basin Desalting Facility	3710014-006	AT	6.37 MGD/ 4,424 gpm
<u>Purchased Treated Sources:</u>			
SDCWA-TRTD-OC-3	3710014-007	PT	40 cfs/ 17,952 gpm
SDCWA-TRTD-OC-4	3710014-017	PT	20 cfs/ 8,977 gpm
SDCWA-TRTD-OC-6	3710014-018	PT	71 cfs/ 31,867 gpm
NCDP #1	3710014-019	PT	74.4 cfs/ 33,393 gpm

AR: Active Raw

AT: Active Treated

PT: Purchased Treated

PR: Purchased Raw

3. The approved treatment for the City includes the following treatment plants and treatment technologies:

Facility	PS Code	Treatment Technology	Treatment
Robert A. Weese SWTP	3710014-002	Direct Filtration	Surface Water
Mission Basin Desalting Facility	3710014-006	Reverse Osmosis, Fe/Mn pressure filters, GAC	TDS, Iron & Manganese, TCP

4. No changes, additions, or modifications shall be made to the sources or treatment mentioned in Permit Provisions (2) and (3) unless an amended water permit has first been obtained from CDPH.
5. All water supplied by the City for domestic purposes shall meet all Maximum Contaminant Levels (MCLs) established by CDPH. If the water quality does not comply with the Drinking Water Standards, treatment shall be provided.
6. Pursuant to Section 64700, Title 22, of the California Code of Regulations (CCR), no chemical or product shall be added to the drinking water as a part of the treatment process unless it has been certified as meeting the specifications of the National Sanitation Foundation/ American National Standards Institute (NSF/ANSI) Standard 60.
7. Pursuant to Section 64591, Title 22, of the CCR, a water system shall not use any chemical, material, lubricant, or product that may come into contact with the drinking water that has not been tested and certified as meeting the specifications of NSF/ANSI 61.
8. All persons responsible for the operation and maintenance of the water system shall be certified in accordance with Title 22, Sections 63750.1 through 64413.7, inclusive, of the CCR. In accordance with these requirements, the City shall employ operator(s) that hold the minimum distribution certification issued by the State of California, listed in the following table:

Water System Name	Distribution System Classification	Chief Distribution Operator Minimum Certification	Shift Distribution Operator Minimum Certification
City of Oceanside	D5	D5	D3

9. Pursuant to Sections 64413.1 and 64413.5, Title 22, of the CCR, each water treatment facility shall have a designated chief treatment plant operator and at least one shift treatment plant operator. In accordance with these requirements, the City shall employ operator(s) that hold the following minimum treatment certifications issued by the State of California to operate the treatment facilities listed in the following table:

Facility Name	Treatment Facility Classification	Chief Treatment Operator Minimum Certification	Shift Treatment Operator Minimum Certification
Robert A. Weese SWTP	T5	T5	T3
City of Oceanside Mission Basin Desalting Facility	T4	T4	T3

10. The City shall comply with Title 17 of the CCR to prevent the water system, sources, and treatment facilities from being contaminated from possible cross-connections. The City shall maintain a program for the protection of the domestic water system against backflow from premises having dual or unsafe water systems in accordance with Title 17 of the CCR. All backflow prevention devices shall be tested annually.

GROUNDWATER BACTERIOLOGICAL MONITORING

11. The City shall collect monthly raw water samples from all active groundwater wells operating during the month. These samples shall be analyzed for coliform bacteria. Bacteriological testing shall be performed using the density analytical method instead of presence absence.
12. All raw source water coliform samples collected at the groundwater wells shall be designated as "special" samples and will not be counted for compliance with the routine distribution system coliform monitoring requirements of the Total Coliform Rule.
13. All coliform-positive well water quality samples shall be analyzed for fecal coliform or E. coli bacteria.
14. The City shall submit the laboratory reports of raw water bacteriological analysis to CDPH by the tenth day of the following month.
15. The City shall notify CDPH within 24-hours if total coliform positive samples have been obtained from a well source and provide CDPH all follow-up sampling results.
16. Well sources that produce total coliform bacteria shall be removed from service following the collection of an additional raw water sample from the well. The raw water sample shall be analyzed for coliform and heterotrophic bacteria. If removal of the well from service may result in a water outage or failure of a drinking water standard, the City shall contact CDPH to discuss interim requirements for the use of this source.

17. Total coliform-positive wells that are removed from service shall be disinfected, pumped to waste until zero chlorine residual is obtained, and re-sampled after 24 hours for coliform and heterotrophic bacteria using the cycle test procedure. All re-samples should be negative for coliform and have a heterotrophic plate count (HPC) less than 500 colonies/mL prior to placing the source back into service.
18. Well sources removed from service for repair and/or maintenance activities shall be disinfected and tested for coliform and heterotrophic bacteria prior to placing them back into service. Well sources can not be placed back into service for the potable supply unless laboratory results show that the wells are coliform absent.

Well No. 9 Chemical Monitoring

19. The City must complete the required source water monitoring for general mineral, volatile organic chemicals (VOC), synthetic organic chemicals (SOC), inorganics, general physical, radioactivity, and unregulated chemicals in accordance with the vulnerability assessment and monitoring table contained in the enclosed Engineering Report, **Attachment No. 5**. The analysis shall be performed by a State certified laboratory and shall be submitted by Electronic Data Transfer (EDT). A complete list of the Primary Station (PS) Code numbers for the City sources is provided in the table in general provision #2. The PS code for Well No. 9 is: **3710014-014**
20. The City shall conduct the required source water monitoring per Title 22, sections 64431-64450, including conducting confirmation sampling and increased monitoring for newly detected contaminants. The City must complete the initial four quarters of monitoring for VOCs, SOCs and radiological parameters.
21. The City shall monitor for nitrate at least once per year at all wells. For those wells that exceed the trigger level of 23 mg/L as NO₃, the City shall initiate quarterly monitoring. The City shall monitor wells for nitrate per its approved treatment plant operations plan, if such plans specify more frequent monitoring.
22. The City shall monitor all approved sources in accordance with Chapter 15, Title 22, of the CCR.

GAC

23. The GAC treatment facilities shall be operated in accordance with an approved Operations Plan. This plan shall describe the operational and emergency procedures, monitoring program and reporting requirements. The City may modify the plan at any time to accommodate changing conditions; however, any modified plan must be submitted to and be approved by CDPH prior to implementation. At any time, CDPH can require the City to modify the plan due to changing conditions, change of laws or regulations, or concerns for public health.
24. The GAC facility's maximum design flow of 3,600 gallons per minute (gpm) shall not be exceeded.
25. Effluent from GAC facilities shall meet all Maximum Contaminant Levels and Action Levels established CDPH.

26. The City shall monitor TCP concentrations through each vessel such that the water system is able to anticipate the breakthrough of TCP in each GAC vessel, and shall arrange for timely and efficient change out of the spent GAC. The water system shall monitor according to the approved Operations Plan which shall include sample locations, frequencies, and set points that will trigger increased TCP monitoring and a GAC media change out.
27. The GAC contactors shall be maintained according to the manufacturer's specifications.
28. The City shall inspect the GAC vessels on a daily basis, and GAC operations records shall be maintained. Daily operations records shall include, at minimum, flow rate, total volume treated, chlorine residual measurements, and monthly bacteriological samples testing.
29. The City shall monitor the bacteriological quality of the treated water at the effluent of each GAC vessel prior to chlorination on a monthly basis, and prior to activating any vessel that has been out-of-service for more than 24 hours and following the installation of GAC media. The City shall have the samples analyzed for total coliform and heterotrophic plate count (HPC) bacteria. The City shall monitor according to the approved Operations Plan which shall include set points that will trigger GAC system maintenance.

DISINFECTION

30. The City shall maintain disinfection levels as described in the enclosed Engineering Report.
31. All treated water from the GAC filters shall be continuously and reliably chlorinated to a residual of at least 0.2 mg/L at all times. The chlorine residual shall be measured continuously at a sampling point located before the treated water reaches the first customer in the system.

RECORDS AND REPORTING

32. The City shall operate the GAC filters according to an approved Operations Plan. Any changes to the Operations Plan shall be submitted to CDPH for review and approval prior to implementation. The City shall update its Operations Plan to include the recent GAC filter addition, and submit the revised Operations Plan to CDPH for review within 60 days of issuance of this permit amendment.
33. The City shall keep a complete record of any emergency and scheduled interruptions in water service. These records should include:
 - a. Location of the problem.
 - b. Cause of the interruption.
 - c. Date and approximate time of the problem.
 - d. Precautions taken to minimize contamination of the supply and notification of affected users.
 - e. Resolution of the interruption.

34. The City shall submit a monthly operation report and copies of any water quality test results to CDPH by the tenth day of the following month. The monthly report shall follow the template contained in the approved Operations Plan.
 - a. For the GAC vessels, the report shall include, at a minimum, flow rates, total volume treated during the month, bed volumes treated since the last carbon change-out, and a summary of the TCP and bacteriological monitoring.
35. The City shall record the water production output on a monthly basis. Written water production records shall be maintained by the City for a minimum of ten years and be available to CDPH during inspections.
36. All water samples for compliance purposes shall be analyzed by a laboratory certified by CDPH's Environmental Laboratory Accreditation Program (ELAP) for each analytical method.
37. All water quality monitoring results analyzed by a certified laboratory shall be submitted to CDPH by Electronic Data Transfer (EDT) using the assigned Primary Station Code (PS_Code) of the monitoring site. Bacteriological monitoring results shall be submitted by hard copy to CDPH unless otherwise directed.

V APPENDICES

<u>Attachment</u>	<u>No.</u>
Permit Amendment Application	1
Location and Site Maps	2
Data Sheets for GAC and Well No. 9	3
Well No. 9 Source Water Quality Results	4
Water Quality Data and Monitoring Matrix for Well No. 9	5
Mission Basin Desalter Facility Process Schematic	6
GAC Process Flow Diagram	7
CEQA Documents	8

Attachment No. 1

STATE OF CALIFORNIA
APPLICATION
FOR
DOMESTIC WATER SUPPLY PERMIT AMENDMENT
FROM

Applicant: City of Oceanside
(Enter the name of legal owner, person(s) or organization)

Address: Water Utilities Department
300 North Coast Highway, Oceanside, CA 92054

System Name: City of Oceanside

System Number: 3710014

TO: California Department of Public Health
Southern California Branch
Drinking Water Field Operations
San Diego District
1350 Front Street, Room 2050
San Diego, California, 92101



Pursuant and subject to the requirements of the California Health and Safety Code, Division 104, Part 12, Chapter 4 (California Safe Drinking Water Act), Article 7, Section 116550, relating to changes requiring an amended permit, application is hereby made to amend an existing water supply permit to add granular activated carbon (GAC) system and an additional water source identified as Well No. 9 to Mission Basin Desalting Facility Water Supply Permit No. 04-14-00PA-000.

I (We) declare under penalty of perjury that the statements on this application and on the accompanying attachments are correct to my (our) knowledge and that I (we) are acting under authority and direction of the responsible legal entity under whose name this application is made.

By: Lonnie Thibodeaux

Title: Water Utilities Director

Address: City of Oceanside Water Utilities Department
300 North Coast Highway, Oceanside, CA 92054

Telephone: 760-435-5823

Dated: July 28, 2008

DDW 07/2007

Attachment No. 2

Attachment No. 3

Attachment No. 4

Clinical Laboratory of San Bernardino, Inc.



Nov. 24th, 2008

Clinical Lab No.: 85868

Mr. Mark Molina
Water Utilities Department
3950 N. River Rd.
Oceanside, CA 92058

Project Name: Title 22 Well Sampling

Enclosed are the results of the analyses for samples received at the laboratory on 10/09/08. Samples were received within temperature range, in correct containers and preservation.

Analyses were performed pursuant to client's chain of custody, within hold times, utilizing EPA or other ELAP approved methodologies.

I certify that the results are within compliance both technically and for completeness. Analytical results are attached to this letter. Please call if any additional information and or assistance are needed.

Thank you for choosing Clinical Lab of San Bernardino for your analytical needs

Sincerely,

John Stu Styles
Client Services Manager

Clinical Laboratory of San Bernardino, Inc.

Summary Report

Client: City of Oceanside
 3950 N. River Rd.
 Oceanside, CA 92058
 Water Utilities

Contact: Mark Molina
 Phone: (760) 435-5949
 Lab Contact: Stu Styles
 Phone: (909) 825-7693
 Lab ID No.: M85868-1A
 Matrix: Water
 Sampler: Tucker

Project: Title 22 Well Sampling

Date Sampled: 10/9/2008
 Time Sampled: 8:30
 Date Received: 10/9/2008
 Date Started: 10/9/2008
 Date Completed: 11/25/2008
 Date Reported: 11/25/2008
 Client ID No.: Well 9

Analyte		CAS No.	Results	DLR	Method
General Minerals					
Chloride (Cl)	mg/L	N/A	490	1.0	EPA 300.0
Sulfate (SO4)	mg/L	N/A	440	0.5	EPA 300.0
Perchlorate (ClO4)	ug/L	N/A	ND	4.0	EPA 314.0
Inorganic Chemicals					
Aluminum (Al)	ug/L	7429-90-5	60	50.0	EPA 200.7
Antimony (Sb)	ug/L	7440-36-0	ND	6.0	SM 3113-B
Arsenic (As)	ug/L	7440-38-2	ND	2.0	SM 3113-B
Barium (Ba)	ug/L	7440-39-3	ND	100.0	EPA 200.7
Beryllium (Be)	ug/L	7440-41-7	ND	1.0	SM 3113-B
Cadmium (Cd)	ug/L	7440-43-9	ND	1.0	SM 3113-B
Chromium (Total Cr)	ug/L	7440-47-3	ND	10.0	SM 3113-B
Lead (Pb)	ug/L	7439-92-1	ND	5.0	SM 3113-B
Mercury (Hg)	ug/L	7439-97-6	ND	1.0	EPA 245.1
Nickel (Ni)	ug/L	7440-02-0	ND	10.0	SM 3113-B
Selenium (Se)	ug/L	7783-00-8	ND	5.0	SM 3113-B
Silver (Ag)	ug/L	7440-22-4	ND	10.0	SM 3113-B
Thallium (Tl)	ug/L	7440-28-0	ND	3.0	EPA 200.9
Vanadium (V)	ug/L	7440-62-2	ND	3.0	EPA 200.9

ND = Not detected at or above indicated DLR; Detection Limit for Reporting

(SOCs)					
Non-Volatile Synthetic Organic Compounds					
Ethylene Dibromide (EDB)	ug/L	106-93-4	ND	0.0	EPA 504.1
Dibromochloropropane (DBCP)	ug/L	96-12-8	ND	0.0	EPA 504.1
Chlorodane	ug/L	57-74-9	ND	0.1	EPA 508.1
Endrin	ug/L	72-20-8	ND	0.1	EPA 508.1
Heptachlor	ug/L	76-44-8	ND	0.0	EPA 508.1
Heptachlor Epoxide	ug/L	1024-57-8	ND	0.0	EPA 508.1
Hexachlorobenzene	ug/L	118-74-1	ND	0.5	EPA 508.1
Hexachlorocyclopentadiene	ug/L	77-47-4	ND	1.0	EPA 508.1
Lindane (gamma-BHC)	ug/L	58-89-9	ND	0.2	EPA 508.1
Methoxychlor	ug/L	72-43-5	ND	10.0	EPA 508.1
Toxaphene	ug/L	8001-35-2	ND	1.0	EPA 508.1
Polychlorinated Biphenyls (Total PCB's)	ug/L	N/A	ND	0.5	EPA 508.1
Bentazon (BASAGRAN)	ug/L	25057-89-0	ND	2.0	EPA 515.4
2,4-D	ug/L	94-75-7	ND	10.0	EPA 515.4
Dalapon	ug/L	75-99-0	ND	10.0	EPA 515.4
Dinoseb (DNBP)	ug/L	88-85-7	ND	2.0	EPA 515.4
Pentachlorophenol (PCP)	ug/L	87-86-5	ND	0.2	EPA 515.4
Picloram	ug/L	88-85-7	ND	1.0	EPA 515.4
2,4,5-TP (SILVEX)	ug/L	93-72-1	ND	1.0	EPA 515.4
Pentachlorophenol (PCP)	ug/L	87-86-5	ND	0.2	EPA 515.4
Alachlor (ALANEX)	ug/L	15972-60-8	ND	1.0	EPA 525.2
Atrazine (AATREX)	ug/L	1912-24-9	ND	0.5	EPA 525.2
Benzo (a) pyrene	ug/L	50-32-8	ND	0.1	EPA 525.2
Diethylhexylphthalate (DEHP)	ug/L	117-81-7	ND	3.0	EPA 525.2
Di (2-ethylhexyl) adipate	ug/L	103-23-1	ND	5.0	EPA 525.2
Molinate (ORDRAM)	ug/L	2212-67-1	ND	2.0	EPA 525.2
Simazine (PRINCEP)	ug/L	122-34-9	ND	1.0	EPA 525.2
Thiobencarb (BOLERO)	ug/L	28249-77-6	ND	1.0	EPA 525.2
Carbofuran (FURADAN)	ug/L	1563-66-2	ND	5.0	EPA 531.1
Oxamyl (VYDATE)	ug/L	23135-22-0	ND	20.0	EPA 531.1
Glyphosate	ug/L	1071-83-6	ND	25.0	EPA 547
Endothall	ug/L	145-73-3	ND	45.0	EPA 548.1
Diquat	ug/L	85-00-7	ND	4.0	EPA 549.2
2,3,7,8-Tetrachlorodibenzo-p-dioxin	pg/L	1746-01-6	ND	5.0	EPA 1613

Clinical Laboratory of San Bernardino, Inc.



Analysis Report: Lab Job M85868

Client: City of Oceanside
3950 N. River Road
Oceanside, CA 92058

Project No.:
Contact: Mark Molina
Phone: (760) 435-5949

Project: Well Sampling

Lab Contact:
Job No.:
COC Log No.:
Lab ID No.: M85868-1A
Batch No.:
Matrix: WATER

Date Sampled: 10/09/08
Date Received: 10/09/08
Date Started: 10/10/08
Date Completed: 10/20/08
Date Reported: 11/12/08
Client ID No.: WELL 9

Sample: WELL 9

Analyte	CAS No.	Results	DLR	Method	
Chloride (Cl)	mg/L	N/A	490	1.0	EPA 300.0
Cyanide (CN)	ug/L	57-12-5	ND	100	SM 4500-CN
Perchlorate (ClO4)	ug/L	N/A	ND	4.0	EPA 314.0
Silver (Ag)	ug/L	7440-22-4	ND	10	SM 3113-B
Sulfate (SO4)	mg/L	N/A	440	0.50	EPA 300.0
Aluminum (Al)	ug/L	7429-90-5	60	50	EPA 200.7
Arsenic (As)	ug/L	7440-38-2	ND	2.0	SM 3113-B
Barium (Ba)	ug/L	7440-39-3	ND	100	EPA 200.7
Beryllium (Be)	ug/L	7440-41-7	ND	1.0	SM 3113-B
Cadmium (Cd)	ug/L	7440-43-9	ND	1.0	SM 3113-B
Chromium (Total Cr)	ug/L	7440-47-3	ND	10	SM 3113-B
Mercury (Hg)	ug/L	7439-97-6	ND	1.0	EPA 245.1
Nickel (Ni)	ug/L	7440-02-0	ND	10	SM 3113-B
Lead (Pb)	ug/L	7439-92-1	ND	5.0	SM 3113-B
Antimony (Sb)	ug/L	7440-36-0	ND	6.0	SM 3113-B
Selenium (Se)	ug/L	7783-00-8	ND	5.0	SM 3113-B
Thallium (Tl)	ug/L	7440-28-0	ND	1.0	EPA 200.9
Vanadium (V)	ug/L	7440-62-2	ND	3.0	EPA 200.9

ND = Not detected at or above indicated DLR; Detection Limit for Reporting

CA DOHS ELAP Accreditation/Registration Number 1086

Post Office Box 329 • San Bernardino, CA 92402 • (909) 825-7693 • Fax (909) 825-7696 • ELAP Number 1088

Clinical Laboratory of San Bernardino, Inc.



Analysis Report: Lab Job M85868X

Client: City of Oceanside
3950 N. River Road
Oceanside, CA 92058

Project No.:
Contact: Mark Molina
Phone: (760)435-5949

Project: Well Sampling

Lab Contact:
Job No.:
COC Log No.:
Lab ID No.: M85868X-1A
Batch No.:
Matrix: WATER

Date Sampled: 10/09/08
Date Received: 10/09/08
Date Started: 10/10/08
Date Completed: 10/21/08
Date Reported: 10/24/08
Client ID No.: WELL 9

Sample: WELL 9

Analyte	CAS No.	Results (ug/L)	DLR (ug/L)	Method
Ethylene Dibromide (EDB)	106-93-4	ND	0.020	EPA 504.1
Dibromochloropropane (DBCP)	96-12-8	ND	0.010	EPA 504.1
Endrin	72-20-8	ND	0.10	EPA 508.1
Lindane (gamma-BHC)	58-89-9	ND	0.20	EPA 508.1
Methoxychlor	72-43-5	ND	10	EPA 508.1
Toxaphene	8001-35-2	ND	1.0	EPA 508.1
Chlordane	57-74-9	ND	0.10	EPA 508.1
Heptachlor	76-44-8	ND	0.010	EPA 508.1
Heptachlor Epoxide	1024-57-8	ND	0.010	EPA 508.1
Hexachlorobenzene	118-74-1	ND	0.50	EPA 508.1
Hexachlorocyclopentadiene	77-47-4	ND	1.0	EPA 508.1
Polychlorinated Biphenyls (Total PCB's)	N/A	ND	0.50	EPA 508.1
Bentazon (BASAGRAN)	25057-89-0	ND	2.0	EPA 515.4
2,4-D	94-75-7	ND	10	EPA 515.4
Dalapon	75-99-0	ND	10	EPA 515.4
Pentachlorophenol (PCP)	87-86-5	ND	0.20	EPA 515.4
Dinoseb (DNBP)	88-85-7	ND	2.0	EPA 515.4
Picloram	1918-02-1	ND	1.0	EPA 515.4
2,4,5-TP (SILVEX)	93-72-1	ND	1.0	EPA 515.4
Diethylhexylphthalate (DEHP)	117-81-7	ND	3.0	EPA 525.2
Di(2-ethylhexyl) adipate	103-23-1	ND	5.0	EPA 525.2
Alachlor (ALANEX)	15972-60-8	ND	1.0	EPA 525.2
Atrazine (AATREX)	1912-24-9	ND	0.50	EPA 525.2
Benzo(a)pyrene	50-32-8	ND	0.10	EPA 525.2
Molinate (ORDRAM)	2212-67-1	ND	2.0	EPA 525.2
Simazine (PRINCEP)	122-34-9	ND	1.0	EPA 525.2
Thiobencarb (BOLERO)	28249-77-6	ND	1.0	EPA 525.2
Carbofuran (FURADAN)	1563-66-2	ND	5.0	EPA 531.1
Oxamyl (VIDATE)	23135-22-0	ND	20	EPA 531.1
Glyphosate	1071-83-6	ND	25	EPA 547

ND = Not detected at or above indicated DLR; Detection Limit for Reporting

Clinical Laboratory of San Bernardino, Inc.



Analysis Report: Dioxins by EPA 1613 Lab Job M85868S

Client: City of Oceanside
3950 N. River Road
Oceanside, CA 92058

Project No.:
Contact: Mark Molina
Phone: (760) 435-5949

Project: Well Sampling

Lab Contact:
Job No.:
COC Log No.:
Lab ID No.: M85868S-1A
Batch No.:
Matrix: WATER

Date Sampled: 10/09/08
Date Received: 10/09/08
Date Started: 10/22/08
Date Completed: 10/23/08
Date Reported: 11/14/08
Client ID No.: WELL 9

Sample: WELL 9

Analyte	CAS No.	Results (pg/L)	DLR (pg/L)	Method
2,3,7,8-Tetrachlorodibenzo-p-dioxin	1746-01-6	ND	5.0	EPA 1613

Analysis performed by Pace Analytical, NELAP No. 01155CA

ND = Not detected at or above indicated DLR; Detection Limit for Reporting

Clinical Laboratory of San Bernardino, Inc.



Analysis Report: Lab Job M85868S

Client: City of Oceanside
3950 N. River Road
Oceanside, CA 92058

Project No.:
Contact: Mark Molina
Phone: (760)435-5949

Project: Well Sampling

Lab Contact:
Job No.:
COC Log No.:
Lab ID No.: M85868S-1A
Batch No.:
Matrix: WATER

Date Sampled: 10/09/08
Date Received: 10/09/08
Date Started: 10/28/08
Date Completed: 11/12/08
Date Reported: 11/14/08
Client ID No.: WELL 9

Sample: WELL 9

Analyte	CAS No.	Results	DLR	Method
Radium 226	pCi/L N/A	ND	1.0	EPA 903.0
Strontium 90	pCi/L N/A	ND	2.0	EPA 905.0
Total Tritium	pCi/L N/A	ND	1000	EPA 906.0
Radium 226 Counting Error	pCi/L N/A	0.187		EPA 903.0
Strontium 90 Counting Error	pCi/L N/A	0.375		EPA 905.0
Total Tritium Counting Error	pCi/L N/A	236		EPA 906.0
Radium 226 Min Det Activity	pCi/L N/A	0.373		EPA 903.0
Strontium 90 Min Det Activ	pCi/L N/A	0.596		EPA 905.0
Total Tritium Min Det Activ	pCi/L N/A	408		EPA 906.0
Radium 228	pCi/L N/A	ND	1.0	RA-05
Radium 228 Counting Error	pCi/L N/A	0.716		RA-05
Radium 228 Min Det Activity	pCi/L N/A	0.255		RA-05

Analysis performed by FGL Environmental, ELAP No. 1573

ND = Not detected at or above indicated DLR; Detection Limit for Reporting.

TEST METHOD	CHEMICAL ALL CHEMICALS REPORTED ug/L	ENTRY #	ANALYSES RESULTS	MCL ug/L	DLR ug/L
524.2	Trichlorotrifluoroethane (FREON 113)	81611	ND	1200	10
524.2	Vinyl Chloride (VC)	39175	ND	.5	0.50
524.2	m,p-Xylene	A-014	ND		1.0
524.2	o-Xylene	77135	ND		0.50
524.2	Total Xylenes (m,p, & o)	81551	ND	1750	
UNREGULATED ORGANIC CHEMICALS					
524.2	tert-Amyl Methyl Ether (TAME)	A-034	ND		3.0
524.2	tert-Butyl Alcohol (TBA)	77035	ND		2.0
524.2	Dichlorodifluoromethane (Freon 12)	34668	ND		0.50
524.2	Ethyl tert-Butyl Ether (ETBE)	A-033	ND		3.0

TEST METHOD	CHEMICAL ALL CHEMICALS REPORTED ug/L	ENTRY #	ANALYSES RESULTS	MCL ug/L	DLR ug/L
508.1	Polychlorinated Biphenyls, Total, as DCB	39516	ND	.5	0.50

CLINICAL LAB OF SAN BERNARDINO, INC
 21881 BARTON ROAD
 GRAND TERRACE, CA 92313

EDT

GENERAL MINERAL & PHYSICAL & INORGANIC ANALYSIS (9/99)

Date of Report: 08/11/12

Sample ID No. M85868-1A

Laboratory

Signature Lab

Name: CLINICAL LABORATORIES OF SAN BERNARDINO Director:

Name of Sampler: TUCKER

Employed By: CITY

Date/Time Sample

Date/Time Sample

Date Analyses

Collected: 08/10/09/0830

Received @ Lab: 08/10/09/1300

Completed: 08/10/20

System

System

Name: OCEANSIDE, CITY OF

Number: 3710014

Name or Number of Sample Source: WELL 09 - PENDING

 * User ID: WAT Station Number: 3710014-014 *
 * Date/Time of Sample: |08|10|09|0830| Laboratory Code: 3761 *
 * YY MM DD TTTT YY MM DD *
 * Date Analysis completed: |08|10|20| *
 * Submitted by: Phone #: *

MCL	REPORTING UNITS	CHEMICAL	ENTRY #	ANALYSES RESULTS	DLR
	mg/L	Total Hardness (as CaCO3) (mg/L)	00900		5.0
	mg/L	Calcium (Ca) (mg/L)	00916		1.0
	mg/L	Magnesium (Mg) (mg/L)	00927		1.0
	mg/L	Sodium (Na) (mg/L)	00929		1.0
	mg/L	Potassium (K) (mg/L)	00937		1.0
Total Cations Meq/L Value: 0.00					
	mg/L	Total Alkalinity (as CaCO3) (mg/L)	00410		5.0
	mg/L	Hydroxide (OH) (mg/L)	71830		5.0
	mg/L	Carbonate (CO3) (mg/L)	00445		5.0
	mg/L	Bicarbonate (HCO3) (mg/L)	00440		5.0
*	mg/L+	Sulfate (SO4) (mg/L)	00945	440	0.50
*	mg/L+	Chloride (Cl) (mg/L)	00940	490	1.0
45	mg/L	Nitrate (as NO3) (mg/L)	71850		2.0
2.0	mg/L	Fluoride (F) (Natural-Source)	00951		0.10
Total Anions Meq/L Value: 22.97					
	Std.Units+	PH (Laboratory) (Std.Units)	00403		
***	umho/cm+	Specific Conductance (E.C.) (umhos/cm)	00095		2.0
****	mg/L+	Total Filterable Residue@180C(TDS) (mg/L)	70300		5.0
15	Units	Apparent Color (Unfiltered) (Units)	00081		3
3	TON	Odor Threshold at 60 C (TON)	00086		1
5	NTU	Lab Turbidity (NTU)	82079		0.1
0.5	mg/L+	MBAS (mg/L)	38260		0.10

* 250-500-600 ** 0.6-1.7 *** 900-1600-2200 **** 500-1000-1500

CLINICAL LAB OF SAN BERNARDINO, INC
 21881 BARTON ROAD
 GRAND TERRACE, CA 92313

EDT

ORGANIC CHEMICAL ANALYSIS (9/99)

Date of Report: 08/11/14 Sample ID No. M85868S-1A
 Laboratory Signature Lab
 Name: PACE ANALYTICAL - MINNEAPOLIS Director: _____
 Name of Sampler: TUCKER Employed By: CITY
 Date/Time Sample Date/Time Sample Date Analyses
 Collected: 08/10/09/0830 Received @ Lab: 08/10/09/1300 Completed: 08/10/23

=====
 System System
 Name: OCEANSIDE, CITY OF Number: 3710014
 Name or Number of Sample Source: WELL 09 - PENDING

 * User ID: WAT Station Number: 3710014-014 *
 * Date/Time of Sample: |08|10|09|0830| Laboratory Code: 2155 *
 * YY MM DD TTTT YY MM DD *
 * Date Analysis completed: |08|10|23| *
 * Submitted by: _____ Phone #: _____ *

Page 1 of 1 REGULATED ORGANIC CHEMICALS

TEST METHOD	CHEMICAL ALL CHEMICALS REPORTED ug/L	ENTRY #	ANALYSES RESULTS	MCL ug/L	DLR ug/L
1613	2,3,7,8-TCDD (Dioxin) Units=picogram/L	34676	ND	30	5.0

CLINICAL LAB OF SAN BERNARDINO, INC
 21881 BARTON ROAD
 GRAND TERRACE, CA 92313

EDT

RADIOACTIVITY ANALYSIS (9/99)

Date of Report: 08/11/14

Sample ID No. M85868S-1A

Laboratory

Signature Lab

Name: FGL ENVIRONMENTAL (SANTA PAULA, CA)

Director:

Name of Sampler: TUCKER

Employed By: CITY

Date/Time Sample

Date/Time Sample

Date Analyses

Collected: 08/10/09/0830

Received @ Lab: 08/10/09/1300

Completed: 08/11/12

System

System

Name: OCEANSIDE, CITY OF

Number: 3710014

Name or Number of Sample Source: WELL 09 - PENDING

 * User ID: WAT Station Number: 3710014-014 *
 * Date/Time of Sample: |08|10|09|0830| Laboratory Code: 5867 *
 * YY MM DD TTTT YY MM DD *
 * Date Analysis completed: |08|11|12| *
 * Submitted by: Phone #: *

MCL REPORT UNITS	CHEMICAL	STORET CODE	ANALYSES RESULTS	DLR
15 pCi/L Gross Alpha		01501		3.0
pCi/L Gross Alpha Counting Error		01502		
pCi/L Gross Alpha MDA (95% Confidence)		A-072		
20 pCi/L Uranium		28012		1.0
pCi/L Uranium Counting Error		A-028		
pCi/L Uranium MDA (95% Confidence)		A-073		
pCi/L Radium 226		09501	ND	1.0
pCi/L Radium 226 Counting Error		09502	0.187	
pCi/L Radium 226 MDA (95% Confidence)		A-074	0.373	
pCi/L Radium 228		11501	ND	1.0
pCi/L Radium 228 Counting Error		11502	0.716	
pCi/L Radium 228 MDA (95% Confidence)		A-075	0.255	
5 pCi/L Ra 226 + Ra 228		11503		2.0
pCi/L Ra 226 + Ra 228 Counting Error		11504		
50 pCi/L Gross Beta		03501		4.0
pCi/L Gross Beta Counting Error		03502		
pCi/L Gross Beta MDA (95% Confidence)		A-077		
8 pCi/L Strontium 90		13501	ND	2.0
pCi/L Strontium 90 Counting Error		13502	0.375	
pCi/L Strontium 90 MDA (95% Confidence)		A-078	0.596	
20000 pCi/L Tritium		07000	ND	1000
pCi/L Tritium Counting Error		07001	236	
pCi/L Tritium MDA (95% Confidence)		A-079	408	

Clinical Laboratory of San Bernardino, Inc.

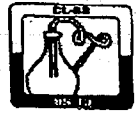

Analysis Report: Lab Job M85868X

Client: City of Oceanside
3950 N. River Road
Oceanside, CA 92508

Project No:
Contact: Mark Molina
Phone: (760) 435-5949

Project: Well Sampling

Date Received: 10/09/08
Date Started: 10/10/08
Date Completed: 10/21/08
Date Reported: 10/24/08

QC Results: METHOD BLANK

Method	Analyte	Result	DLR	Accept Crit	Units
EPA 504.1	EDB	ND	0.10	< 0.02	ug/L
EPA 504.1	DBCP	ND	0.10	< 0.01	ug/L
EPA 508.1	Lindane	ND	0.05	< 0.20	ug/L
EPA 508.1	Endrin	ND	0.03	< 0.10	ug/L
EPA 508.1	Heptachlor	ND	0.003	< 0.01	ug/L
EPA 508.1	Heptachlor epoxide	ND	0.003	< 0.01	ug/L
EPA 508.1	Hexachlorobenzene	ND	0.13	< 0.50	ug/L
EPA 508.1	Hexachlorocyclopentadiene	ND	0.25	< 1.0	ug/L
EPA 508.1	Methoxychlor	ND	2.5	< 10	ug/L
EPA 515.4	Dalapon	ND	10	< 10	ug/L
EPA 515.4	Dicamba	ND	1.5	< 1.5	ug/L
EPA 515.4	2,4-D	ND	10	< 10	ug/L
EPA 515.4	PCP	ND	0.20	< 0.20	ug/L
EPA 515.4	Silvex	ND	1.0	< 1.0	ug/L
EPA 515.4	2,4,5-T	ND	1.0	< 1.0	ug/L
EPA 515.4	Dinoseb	ND	2.0	< 2.0	ug/L
EPA 515.4	Bentazon	ND	2.0	< 2.0	ug/L
EPA 515.4	Picloram	ND	1.0	< 1.0	ug/L
EPA 525.2	Molinate	ND	2.0	< 2.0	ug/L
EPA 525.2	Simazine	ND	1.0	< 1.0	ug/L
EPA 525.2	Atrazine	ND	0.50	< 0.50	ug/L
EPA 525.2	Alachlor	ND	1.0	< 1.0	ug/L
EPA 525.2	Thiobencarb	ND	1.0	< 1.0	ug/L
EPA 525.2	DEHA	ND	5.0	< 5.0	ug/L
EPA 525.2	DEHP	ND	3.0	< 3.0	ug/L
EPA 525.2	Benzo(a)pyrene	ND	0.10	< 0.10	ug/L
EPA 531.1	Oxamyl (Vydate)	ND	2.0	< 20	ug/L
EPA 531.1	Carbofuran	ND	2.0	< 5.0	ug/L
EPA 547	Glyphosate	ND	20	< 25	ug/L

Clinical Laboratory of San Bernardino, Inc.



Analysis Report: Lab Job M95868X

Client: City of Oceanside
3950 N. River Road
Oceanside, CA 92508

Project No:
Contact: Mark Molina
Phone: (760) 435-5949

Project: Well Sampling

Date Received: 10/09/08
Date Started: 10/10/08
Date Completed: 10/21/08
Date Reported: 10/24/08

QC Results: LABORATORY CONTROL SAMPLE DUPLICATE

Method	Analyte	LCSD Conc	True LCSD Conc	Recov (%)	Accept Range (%)	Units
EPA 524.2	1,1,1-Trichloroethane (1,1,1 TCA)	9.5	10	95	70-130	ug/L
EPA 524.2	1,1,2,2-Tetrachloroethane	10	10	104	70-130	ug/L
EPA 524.2	1,1,2-Trichloroethane (1,1,2-TCA)	11	10	108	70-130	ug/L
EPA 524.2	1,1-Dichloroethane (1,1-DCA)	9.8	10	98	70-130	ug/L
EPA 524.2	1,1-Dichloroethylene (1,1-DCE)	9.8	10	98	70-130	ug/L
EPA 524.2	1,2-Dichlorobenzene (o-DCB)	10	10	104	70-130	ug/L
EPA 524.2	1,2-Dichloroethane	10	10	102	70-130	ug/L
EPA 524.2	1,2-Dichloropropane	10	10	103	70-130	ug/L
EPA 524.2	1,4-Dichlorobenzene (p-DCB)	9.6	10	96	70-130	ug/L
EPA 524.2	Benzene	10	10	101	70-130	ug/L
EPA 524.2	Bromodichloromethane	9.9	10	99	70-130	ug/L
EPA 524.2	Bromoform	9.7	10	97	70-130	ug/L
EPA 524.2	Carbon Tetrachloride	9.8	10	98	70-130	ug/L
EPA 524.2	Chlorobenzene	9.6	10	96	70-130	ug/L
EPA 524.2	Chloroform (Trichloromethane)	9.7	10	97	70-130	ug/L
EPA 524.2	cis-1,3-Dichloropropene	10	10	102	70-130	ug/L
EPA 524.2	Dibromochloromethane	10	10	105	70-130	ug/L
EPA 524.2	Ethyl Benzene	10	10	102	70-130	ug/L
EPA 524.2	Methyl tert-Butyl Ether	9.5	10	95	70-130	ug/L
EPA 524.2	Dichloromethane (Methylene Chloride)	9.4	10	94	70-130	ug/L
EPA 524.2	Tetrachloroethylene (PCE)	11	10	107	70-130	ug/L
EPA 524.2	Toluene	11	10	110	70-130	ug/L
EPA 524.2	trans-1,2-Dichloroethylene (t-1,2-DCE)	9.4	10	94	70-130	ug/L
EPA 524.2	trans-1,3-Dichloropropene	10	10	102	70-130	ug/L
EPA 524.2	Trichloroethylene (TCE)	9.7	10	97	70-130	ug/L
EPA 524.2	Trichlorofluoromethane (Freon 11)	11	10	111	70-130	ug/L
EPA 524.2	Vinyl Chloride (VC)	9.6	10	96	70-130	ug/L
EPA 524.2	m,p-Xylene	20	20	101	70-130	ug/L
EPA 524.2	o-Xylene	9.3	10	93	70-130	ug/L
EPA 524.2	1,1,2-trichloro-1,2,2-trifluoroethane	9.2	10	92	70-130	ug/L
EPA 524.2	cis-1,2-dichloroethene	10	10	103	70-130	ug/L
EPA 524.2	Styrene	11	10	105	70-130	ug/L
EPA 524.2	1,2,4-trichlorobenzene	9.7	10	97	70-130	ug/L
EPA 524.2	SURR-Bromofluorobenzene	1.1	1.0	105	50-150	ug/L
EPA 524.2	SURR-1,2-dichlorobenzene	1.0	1.0	101	50-150	ug/L

Clinical Laboratory of San Bernardino, Inc.

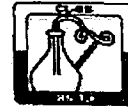

Analysis Report: Lab Job M85866X

Client: City of Oceanside
3950 N. River Road
Oceanside, CA 92508

Project No:
Contact: Mark Molina
Phone: (760) 435-5949

Project: Well Sampling

Date Received: 10/09/08
Date Started: 10/10/08
Date Completed: 10/21/08
Date Reported: 10/24/08

QC Results: LABORATORY CONTROL SAMPLE DUPLICATE

Method	Analyte	LCSD Conc	True LCSD Conc	Recov (%)	Accept Range (%)	Units
EPA 504.1	EDB	0.21	0.25	83	70-130	ug/L
EPA 504.1	DBCP	0.29	0.25	118	70-130	ug/L
EPA 508.1	Lindane	0.20	0.20	98	70-130	ug/L
EPA 508.1	Endrin	0.10	0.10	98	70-130	ug/L
EPA 508.1	Heptachlor	0.01	0.01	80	70-130	ug/L
EPA 508.1	Heptachlor epoxide	0.01	0.01	90	70-130	ug/L
EPA 508.1	Hexachlorobenzene	0.39	0.50	78	70-130	ug/L
EPA 508.1	Hexachlorocyclopentadiene*	0.7	1.0	69	70-130	ug/L
EPA 508.1	Methoxychlor	10.6	10	106	70-130	ug/L
EPA 515.4	Dalapon	9.0	10	90	70-130	ug/L
EPA 515.4	Dicamba	1.6	1.5	105	70-130	ug/L
EPA 515.4	2,4-D	10	10	102	70-130	ug/L
EPA 515.4	PCP*	0.26	0.20	131	70-130	ug/L
EPA 515.4	Silvex	1.3	1.0	126	70-130	ug/L
EPA 515.4	2,4,5-T	1.1	1.0	107	70-130	ug/L
EPA 515.4	Dinoseb	1.9	2.0	93	70-130	ug/L
EPA 515.4	Bentazon	2.0	2.0	98	70-130	ug/L
EPA 515.4	Picloram	1.0	1.0	103	70-130	ug/L
EPA 525.2	Molinate	11	10	112	70-130	ug/L
EPA 525.2	Simazine	4.8	5.0	96	70-130	ug/L
EPA 525.2	Atrazine	2.8	2.5	112	70-130	ug/L
EPA 525.2	Alachlor	5.6	5.0	112	70-130	ug/L
EPA 525.2	Thiobencarb	5.9	5.0	118	70-130	ug/L
EPA 525.2	DEHA	27	25	107	70-130	ug/L
EPA 525.2	DEHP	16	15	108	70-130	ug/L
EPA 525.2	Benzo(a)pyrene*	0.66	0.50	132	70-130	ug/L
EPA 531.1	Oxamyl (Vydate)	44	50	87	70-130	ug/L
EPA 531.1	Carbofuran	43	50	85	70-130	ug/L
EPA 547	Glyphosate	59	50	117	70-130	ug/L

*PCP LCSD is outside allowable range; block results validated by LCS recovery.

*Hexachlorocyclopentadiene LCSD is outside allowable range; block results validated by the DLR recovery.

*Benzo(a)pyrene LCSD is outside allowable range; block results validated by LCS recovery.

Clinical Laboratory of San Bernardino, Inc.

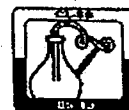

Analysis Report: Lab Job M85868X

Client: City of Oceanside
3950 N. River Road
Oceanside, CA 92508

Project No:
Contact: Mark Molina
Phone: (760) 435-5949

Project: Well Sampling

Date Received: 10/09/08
Date Started: 10/10/08
Date Completed: 10/21/08
Date Reported: 10/24/08

QC Results: LABORATORY CONTROL SAMPLE RPD

Method	Analyte	RPD (%)	Accept Crit (%)
EPA 504.1	EDB	12	< 20
EPA 504.1	DBCP	8.9	< 20
EPA 508.1	Lindane	18	< 30
EPA 508.1	Endrin	13	< 30
EPA 508.1	Heptachlor	13	< 30
EPA 508.1	Heptachlor epoxide	0.0	< 30
EPA 508.1	Hexachlorobenzene	16	< 30
EPA 508.1	Hexachlorocyclopentadiene	15	< 30
EPA 508.1	Methoxychlor	2.8	< 30
EPA 515.4	Dalapon	8.5	< 20
EPA 515.4	Dicamba	0.38	< 20
EPA 515.4	2,4-D	0.32	< 20
EPA 515.4	PCP	13	< 20
EPA 515.4	Silvex	7.2	< 20
EPA 515.4	2,4,5-T	3.1	< 20
EPA 515.4	Dinoseb	4.3	< 20
EPA 515.4	Bentazon	1.3	< 20
EPA 515.4	Picloram	0.49	< 20
EPA 525.2	Molinate	6.9	≤ 30
EPA 525.2	Simazine	25	≤ 30
EPA 525.2	Atrazine	0.07	≤ 30
EPA 525.2	Alachlor	0.0	≤ 30
EPA 525.2	Thiobencarb	3.3	≤ 30
EPA 525.2	DEHA	5.4	≤ 30
EPA 525.2	DEHP	2.7	≤ 30
EPA 525.2	Benzo(a)pyrene	1.5	≤ 30
EPA 531.1	Oxamyl (Vydate)	3.3	< 20
EPA 531.1	Carbofuran	0.24	< 20
EPA 547	Glyphosate	16	< 30

Clinical Laboratory of San Bernardino, Inc.



Analysis Report: Lab Job M85868X

Client: City of Oceanside
3950 N. River Road
Oceanside, CA 92508

Project No:
Contact: Mark Molina
Phone: (760) 435-5949

Project: Well Sampling

Date Received: 10/09/08
Date Started: 10/10/08
Date Completed: 10/21/08
Date Reported: 10/24/08

QC Results: MATRIX SPIKE SAMPLE DUPLICATES

Method	Analyte	MSD Conc	True Spike Conc	Recov (%)	Accept Range (%)	Units
EPA 504.1	EDB	0.24	0.25	94	70-130	ug/L
EPA 504.1	DBCP	0.30	0.25	120	70-130	ug/L
EPA 508.1	Lindane*	0.12	0.20	60	65-135	ug/L
EPA 508.1	Endrin	0.07	0.10	71	65-135	ug/L
EPA 508.1	Heptachlor*	0.01	0.01	50	65-135	ug/L
EPA 508.1	Heptachlor epoxide	0.01	0.01	70	65-135	ug/L
EPA 508.1	Hexachlorobenzene*	0.23	0.50	46	65-135	ug/L
EPA 508.1	Hexachlorocyclopentadiene*	0.42	1.0	42	65-135	ug/L
EPA 508.1	Methoxychlor	8.1	10	81	65-135	ug/L
EPA 515.4	Dalapon	11	15	72	70-130	ug/L
EPA 515.4	Dicamba	2.5	2.5	101	70-130	ug/L
EPA 515.4	2,4-D	13	15	88	70-130	ug/L
EPA 515.4	PCP*	NR**	0.30	NR**	70-130	ug/L
EPA 515.4	Silvex	1.5	1.5	98	70-130	ug/L
EPA 515.4	2,4,5-T	1.6	1.5	110	70-130	ug/L
EPA 515.4	Dinoseb	3.4	3.0	112	70-130	ug/L
EPA 515.4	Bentazon	3.0	3.0	99	70-130	ug/L
EPA 515.4	Picloram	1.9	1.5	127	70-130	ug/L
EPA 525.2	Molinate	12	10	118	70-130	ug/L
EPA 525.2	Simazine	6.2	5.0	123	70-130	ug/L
EPA 525.2	Atrazine*	3.5	2.5	140	70-130	ug/L
EPA 525.2	Alachlor*	6.8	5.0	136	70-130	ug/L
EPA 525.2	Thiobencarb*	6.7	5.0	134	70-130	ug/L
EPA 525.2	DEHA	29	25	116	70-130	ug/L
EPA 525.2	DEHP	17	15	113	70-130	ug/L
EPA 525.2	Benzo(a)pyrene*	0.85	0.50	170	70-130	ug/L
EPA 531.1	Oxamyl (Vydate)	20	20	100	65-135	ug/L
EPA 531.1	Carbofuran	20	20	101	65-135	ug/L
EPA 547	Glyphosate	45	50	89	65-135	ug/L

*PCP matrix spike recovery has no result due to value exceeding the calibration range.

*Matrix spike duplicate recoveries are outside allowable range due to matrix interference.

**NR means no result.

Clinical Laboratory of San Bernardino, Inc.



Analysis Report: Lab Job MS5868R

Client: City of Oceanside
3950 N. River Road
Oceanside, CA 92508

Project No:
Contact: Mark Molina
Phone: (760) 435-5949

Project: Well Sampling

Date Received: 10/09/08
Date Started: 10/13/08
Date Completed: 10/22/08
Date Reported: 10/24/08

QC Results: METHOD BLANK

Method	Analyte	Result	DLR	Accept Crit	Units
EPA 900.0	Alpha	ND	3.0	< 3.0	pCi/L
EPA 900.0	Beta	ND	4.0	< 4.0	pCi/L
EPA 908.0	Uranium	ND	1.0	< 1.0	pCi/L

Clinical Laboratory of San Bernardino, Inc.



Analysis Report: Lab Job M85868

Client: City of Oceanside
3950 N. River Road
Oceanside, CA 92508

Project No:
Contact: Mark Molina
Phone: (760) 435-5949

Project: Well Sampling

Date Received: 10/09/08
Date Started: 10/10/08
Date Completed: 10/20/08
Date Reported: 11/05/08

QC Results: LABORATORY CONTROL SAMPLE

Method	Analyte	LCS Conc	True LCS Conc	Recov (%)	Accept Range (%)	Units
SM 4500-CN	Cyanide (CN)	442	500	88	80-120	ug/L
EPA 314.0	Perchlorate	11	10	108	90-110	ug/L
EPA 300.0	Chloride	47	50	93	90-110	mg/L
EPA 300.0	Sulfate	49	50	99	90-110	mg/L
EPA 200.7	Aluminum	114	100	114	85-115	ug/L
EPA 200.7	Barium	108	100	108	85-115	ug/L
EPA 200.9	Thallium	11	10	110	90-110	ug/L
EPA 200.9	Vanadium	9.8	10	98	90-110	ug/L
SM 3113 B	Antimony	11	10	108	90-110	ug/L
SM 3113 B	Arsenic	11	10	108	90-110	ug/L
SM 3113 B	Beryllium	2.6	2.5	104	90-110	ug/L
SM 3113 B	Cadmium	2.7	2.5	108	90-110	ug/L
SM 3113 B	Chromium	9.9	10	99	90-110	ug/L
SM 3113 B	Lead	10	10	102	90-110	ug/L
SM 3113 B	Nickel	9.6	10	96	90-110	ug/L
SM 3113 B	Selenium	10	10	101	90-110	ug/L
SM 3113 B	Silver	10	10	102	90-110	ug/L
EPA 245.1	Mercury	2.2	2.0	109	90-110	ug/L

Clinical Laboratory of San Bernardino, Inc.



Analysis Report: Lab Job M85868

Client: City of Oceanside
3950 N. River Road
Oceanside, CA 92508

Project No:
Contact: Mark Molina
Phone: (760) 435-5949

Project: Well Sampling

Date Received: 10/09/08
Date Started: 10/10/08
Date Completed: 10/20/08
Date Reported: 11/05/08

QC Results: MATRIX SPIKE SAMPLE

Method	Analyte	MS Conc	True Spike Conc	Recov (%)	Accept Range (%)	Units
SM 4500-CN	Cyanide (CN)	507	500	101	80-120	ug/L
EPA 314.0	Perchlorate	26	25	102	80-120	ug/L
EPA 300.0	Chloride	23	25	91	80-120	mg/L
EPA 300.0	Sulfate	25	25	99	80-120	mg/L
EPA 200.7	Aluminum	485	500	97	70-130	ug/L
EPA 200.7	Barium	369	500	74	70-130	ug/L
EPA 200.9	Thallium	25	25	99	70-130	ug/L
EPA 200.9	Vanadium	22	25	87	70-130	ug/L
SM 3113 B	Antimony	18	25	73	70-130	ug/L
SM 3113 B	Arsenic	25	25	98	70-130	ug/L
SM 3113 B	Beryllium	3.2	2.5	128	70-130	ug/L
SM 3113 B	Cadmium	2.7	2.5	107	70-130	ug/L
SM 3113 B	Chromium	11	10	108	70-130	ug/L
SM 3113 B	Lead	26	25	104	70-130	ug/L
SM 3113 B	Nickel	25	25	101	70-130	ug/L
SM 3113 B	Selenium	23	25	90	70-130	ug/L
SM 3113 B	Silver	3.5	5.0	71	70-130	ug/L
EPA 245.1	Mercury	1.7	2.0	83	70-130	ug/L

Clinical Laboratory of San Bernardino, Inc.

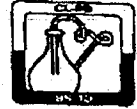

Analysis Report: Lab Job M85868

Client: City of Oceanside
3950 N. River Road
Oceanside, CA 92508

Project No:
Contact: Mark Molina
Phone: (760) 435-5949

Project: Well Sampling

Date Received: 10/09/08
Date Started: 10/10/08
Date Completed: 10/20/08
Date Reported: 11/05/08

QC Results: MATRIX SPIKE RPD

Method	Analyte	RPD (%)	Accept Crit (%)
SM 4500-CN	Cyanide (CN)	6.5	< 20
EPA 314.0	Perchlorate	0.46	< 15
EPA 300.0	Chloride	3.3	< 20
EPA 300.0	Sulfate	1.4	< 20
EPA 200.7	Aluminum	25	≤ 30
EPA 200.7	Barium	21	≤ 30
EPA 200.9	Thallium	0.81	≤ 30
EPA 200.9	Vanadium	8.4	≤ 30
SM 3113 B	Antimony	5.8	≤ 30
SM 3113 B	Arsenic	1.2	≤ 30
SM 3113 B	Beryllium	1.3	≤ 30
SM 3113 B	Cadmium	0.0	≤ 30
SM 3113 B	Chromium	0.93	≤ 30
SM 3113 B	Lead	0.76	≤ 30
SM 3113 B	Nickel	5.3	≤ 30
SM 3113 B	Selenium	0.0	≤ 30
SM 3113 B	Silver	3.2	≤ 30
EPA 245.1	Mercury	0.60	< 20

Clinical Laboratory of San Bernardino, Inc.



Analysis Report: Lab Job M85868R

Client: City of Oceanside
3950 N. River Road
Oceanside, CA 92508

Project No:
Contact: Mark Molina
Phone: (760) 435-5949

Project: Well Sampling

Date Received: 10/09/08
Date Started: 10/13/08
Date Completed: 10/22/08
Date Reported: 10/24/08

QC Results: LABORATORY CONTROL SAMPLE

Method	Analyte	LCS Conc	True LCS Conc	Recov (%)	Accept Range (%)	Units
EPA 900.0	Alpha	17	20	84	70-130	pCi/L
EPA 900.0	Beta	21	20	103	70-130	pCi/L
EPA 908.0	Uranium	22	20	112	70-130	pCi/L

Clinical Laboratory of San Bernardino, Inc.



Analysis Report: Lab Job M85868R

Client: City of Oceanside
3950 N. River Road
Oceanside, CA 92508

Project-No:
Contact: Mark Molina
Phone: (760) 435-5949

Project: Well Sampling

Date Received: 10/09/08
Date Started: 10/13/08
Date Completed: 10/22/08
Date Reported: 10/24/08

QC Results: MATRIX SPIKE SAMPLE

Method	Analyte	MS Conc	True Spike Conc	Recov (%)	Accept Range (%)	Units
EPA 900.0	Alpha	21	20	107	70-130	pCi/L
EPA 900.0	Beta	20	20	102	70-130	pCi/L
EPA 908.0	Uranium	13	10	127	70-130	pCi/L

Clinical Laboratory of San Bernardino, Inc.

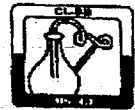

Analysis Report: Lab Job M85868R

Client: City of Oceanside
3950 N. River Road
Oceanside, CA 92508

Project No:
Contact: Mark Molina
Phone: (760) 435-5949

Project: Well Sampling

Date Received: 10/09/08
Date Started: 10/13/08
Date Completed: 10/22/08
Date Reported: 10/24/08

QC Results: MATRIX SPIKE RPD

Method	Analyte	RPD (%)	Accept Crit (%)
EPA 900.0	Alpha	16	< 50
EPA 900.0	Beta	0.07	< 50
EPA 908.0	Uranium	11	< 50

Attachment No. 5

CALIFORNIA DEPARTMENT OF PUBLIC HEALTH, DIVISION OF DRINKING WATER
Monitoring Guidelines - Ground Water Schedule
for the 9-Year Compliance Cycle 1/1/2002 through 12/31/2010

System Name: City of Oceanside

System Number: 3710014

Date: March 2009

Parameter	STORET	MCL	Units	DLR	Trigger	Monitoring Frequency (a)		Title 22
						Active Wells	Standby Wells	
Inorganic Chemicals								
ALUMINUM	01105	1,000	UG/L	50	200 ^(b)	every 3 years	every 9 years	PI
ANTIMONY	01097	6	UG/L	6	6	every 3 years	every 9 years	PI
ARSENIC	01002	50	UG/L	2	50	every 3 years	every 9 years	PI
ASBESTOS	81855	7	MFL	0.2	7	waived	waived	PI
BARIUM	01007	1,000	UG/L	100	1,000	every 3 years	every 9 years	PI
BERYLLIUM	01012	4	UG/L	1	4	every 3 years	every 9 years	PI
CADMIUM	01027	5	UG/L	1	5	every 3 years	every 9 years	PI
CHROMIUM (TOTAL)	01034	50	UG/L	10	50	every 3 years	every 9 years	PI
COPPER	01042	1,000	UG/L	50	1,000	every 3 years	every 9 years	SI
CYANIDE	01291	150	UG/L	100	150	once	once	PI
FLUORIDE	00951	2	MG/L	0.1	1.7	every 3 years	every 9 years	SI
IRON	01045	300	UG/L	100	300	every 3 years	every 9 years	SI
LEAD	01051	15 ^(c)	UG/L	5	15	every 3 years	every 9 years	PI
MANGANESE	01055	50	UG/L	20	50	every 3 years	every 9 years	SI
MERCURY	71900	2	UG/L	1	2	every 3 years	every 9 years	SI
NICKEL	01067	100	UG/L	10	100	every 3 years	every 9 years	PI
NITRATE (AS NO3)	71850	45	MG/L	2	23	annually	every 9 years	PI
NITRITE (AS N)	00820	1000	UG/L	400	500	every 3 years	every 9 years	PI
PERCHLORATE (f)	A-031	6	UG/L	4	4	every 3 years	every 9 years	PI
PERCHLORATE (f)	01147	50	UG/L	5	50	every 3 years	every 9 years	PI
SELENIUM	01077	100	UG/L	10	100	every 3 years	every 9 years	SI
SILVER	01059	2	UG/L	1	2	every 3 years	every 9 years	PI
THALLIUM	01092	5000	UG/L	50	5000	every 3 years	every 9 years	SI
ZINC								
General Mineral								
TOTAL HARDNESS (AS CaCO3)	00900		MG/L			every 3 years	every 9 years	SI
BICARBONATE ALKALINITY	00440		MG/L			every 3 years	every 9 years	SI
CARBONATE ALKALINITY	00445		MG/L			every 3 years	every 9 years	SI
HYDROXIDE ALKALINITY	71830		MG/L			every 3 years	every 9 years	SI
CALCIUM	00916		MG/L			every 3 years	every 9 years	SI
MAGNESIUM	00927		MG/L			every 3 years	every 9 years	SI
SODIUM	00929		MG/L			every 3 years	every 9 years	SI
SULFATE	00945	250, 500, 600 ^(d)	MG/L	0.5	500	every 3 years	every 9 years	SI
CHLORIDE	00940	250, 500, 600 ^(d)	MG/L		500	every 3 years	every 9 years	SI
General Physical								
TOTAL DISSOLVED SOLIDS	70300	500, 1000, 1500 ^(d)	MG/L		1000	every 3 years	every 9 years	SI
SPECIFIC CONDUCTANCE	00095	900, 1600, 2200 ^(d)	US		1600	every 3 years	every 9 years	SI
TURBIDITY (LAB)	82079	5	NTU		5	every 3 years	every 9 years	SI
PH (LABORATORY)	00403		UNITS			every 3 years	every 9 years	SI
COLOR	00081	15	UNITS		15	every 3 years	every 9 years	SI
ODOR THRESHOLD @ 60 C	00086	3	TON	1	3	every 3 years	every 9 years	SI
FOAMING AGENTS (MBAS)	38260	500	UG/L		500	every 3 years	every 9 years	SI
CORROSIVITY (AGGRESSIVENESS INDEX)	82383	Non-corrosive				every 3 years	every 9 years	SI

System Number: 3710014

Parameter	STORET	MCL	Units	DLR	Trigger	Monitoring Frequency (a)		Title 22
						Active Wells	Standby Wells	
Radical (g)								
GROSS ALPHA	01501	15 ^(b)	PCI/L	3	5	(h)	every 9 years	RAD
GROSS BETA	03501	50	PCI/L	4	50	waived	waived	RAD
RADIUM 226	09501	5 ^(c)	PCI/L	1	5	(i)	waived	RAD
RADIUM 228	11501	5 ^(c)	PCI/L	1	5	(i)	waived	RAD
STRONTIUM-90	13501	8	PCI/L	2	8	waived	waived	RAD
TRITIUM	07000	20,000	PCI/L	1,000	20,000	waived	waived	RAD
URANIUM	28012	20	PCI/L	2	20	(i)	waived	RAD
Bacteriological								
Total Coliform (Presence/Absence)								BAC
Fecal Coliform or E. coli								BAC
Heterotrophic Plate Count								BAC
Regulated Volatile Organic Chemicals (m)								
BENZENE	34030	1	UG/L	0.5	0.5	annually	every 9 years	PVOC
CARBON TETRACHLORIDE	32102	0.5	UG/L	0.5	0.5	annually	every 9 years	PVOC
1,2-DICHLOROBENZENE	34536	600	UG/L	0.5	0.5	annually	every 9 years	PVOC
1,4-DICHLOROBENZENE	34571	5	UG/L	0.5	0.5	annually	every 9 years	PVOC
1,1-DICHLOROETHANE	34496	5	UG/L	0.5	0.5	annually	every 9 years	PVOC
1,2-DICHLOROETHANE	34531	0.5	UG/L	0.5	0.5	annually	every 9 years	PVOC
1,1-DICHLOROETHYLENE	34501	6	UG/L	0.5	0.5	annually	every 9 years	PVOC
CIS-1,2-DICHLOROETHYLENE	77093	6	UG/L	0.5	0.5	annually	every 9 years	PVOC
TRANS-1,2-DICHLOROETHYLENE	34546	10	UG/L	0.5	0.5	annually	every 9 years	PVOC
DICHLOROMETHANE	34423	5	UG/L	0.5	0.5	annually	every 9 years	PVOC
1,2-DICHLOROPROPANE	34541	5	UG/L	0.5	0.5	annually	every 9 years	PVOC
1,3-DICHLOROPROPENE (TOTAL)	34561	0.5	UG/L	0.5	0.5	annually	every 9 years	PVOC
ETHYLBENZENE	34371	300	UG/L	0.5	0.5	annually	every 9 years	PVOC
METHYL-TERT-BUTYL-ETHER (MTBE)	48491	13	UG/L	3.0	5	annually	every 9 years	PVOC
MONOCHLOROBENZENE	34301	70	UG/L	0.5	0.5	annually	every 9 years	PVOC
STYRENE	77128	100	UG/L	0.5	0.5	annually	every 9 years	PVOC
1,1,2,2-TETRACHLOROETHANE	34516	1	UG/L	0.5	0.5	annually	every 9 years	PVOC
TETRACHLOROETHYLENE	34475	5	UG/L	0.5	0.5	annually	every 9 years	PVOC
TOLUENE	34010	150	UG/L	0.5	0.5	annually	every 9 years	PVOC
1,2,4-TRICHLOROBENZENE	34551	5	UG/L	0.5	0.5	annually	every 9 years	PVOC
1,1,1-TRICHLOROETHANE	34506	200	UG/L	0.5	0.5	annually	every 9 years	PVOC
1,1,2-TRICHLOROETHANE	34511	5	UG/L	0.5	0.5	annually	every 9 years	PVOC
TRICHLOROETHYLENE	39180	5	UG/L	0.5	0.5	annually	every 9 years	PVOC
TRICHLOROFLUOROMETHANE (FREON 11)	34488	150	UG/L	5	5	annually	every 9 years	PVOC
1,1,2-TRICHLORO-1,2,2-TRIFLUOROETHANE (FREON 113)	81611	1200	UG/L	10	10	annually	every 9 years	PVOC
VINYL CHLORIDE	39175	0.5	UG/L	0.5	0.5	annually	every 9 years	PVOC
XYLENES (TOTAL)	81551	1,750	UG/L	0.5	0.5	annually	every 9 years	PVOC

Parameter	STORET	MCL	Units	DLR	Trigger	Monitoring Frequency (a)		Title 22
						Active Wells	Standby Wells	
Regulated Synthetic Organic Chemicals (m)								
ALACHLOR	77825	2	UG/L	1	1	every 3 years	waived	PSOC
ATRAZINE	39033	1	UG/L	0.5	0.5	annually	every 9 years	PSOC
BENTAZON	38710	18	UG/L	2	2	every 3 years	waived	PSOC
BENZO(A)PYRENE	34247	0.2	UG/L	0.1	0.1	every 3 years	waived	PSOC
CARBOFURAN	81405	18	UG/L	5	5	every 3 years	waived	PSOC
CHLORDANE	39350	0.1	UG/L	0.1	0.1	every 3 years	waived	PSOC
2,4-D	39730	70	UG/L	10	10	every 3 years	waived	PSOC
DALAPON	38432	200	UG/L	10	10	every 3 years	waived	PSOC
DIBROMOCHLOROPROPANE (DBCP)	38761	0.2	UG/L	0.01	0.01	annually	every 9 years	PSOC
DI(2-ETHYLHEXYL)ADIPATE	A-026	400	UG/L	5	5	every 3 years	waived	PSOC
DI(2-ETHYLHEXYL)PHTHALATE	39100	4	UG/L	3	3	every 3 years	waived	PSOC
DINOSEB	81287	7	UG/L	2	2	every 3 years	waived	PSOC
DICUAT	78885	20	UG/L	4	4	every 3 years	waived	PSOC
ENDOTHALL	38926	100	UG/L	45	45	every 3 years	waived	PSOC
ENDRIN	39390	2	UG/L	0.1	0.1	every 3 years	waived	PSOC
ETHYLENE DIBROMIDE (EDB)	77651	0.05	UG/L	0.02	0.02	annually	every 9 years	PSOC
GLYPHOSATE	79743	700	UG/L	25	25	every 3 years	waived	PSOC
HEPTACHLOR EPOXIDE	39410	0.01	UG/L	0.01	0.01	every 3 years	waived	PSOC
HEXACHLOROBENZENE	39420	0.01	UG/L	0.01	0.01	every 3 years	waived	PSOC
HEXACHLOROCYCLOPENTADIENE	39700	1	UG/L	0.5	0.5	every 3 years	waived	PSOC
LINDANE	34386	50	UG/L	1	1	every 3 years	waived	PSOC
METHOXYCHLOR	39340	0.2	UG/L	0.2	0.2	every 3 years	waived	PSOC
MOLINATE	39480	30	UG/L	10	10	every 3 years	waived	PSOC
OXAMYL	82199	20	UG/L	2	2	every 3 years	waived	PSOC
PENTACHLOROPHENOL	38865	50	UG/L	20	20	every 3 years	waived	PSOC
PICLORAM	39032	1	UG/L	0.2	0.2	every 3 years	waived	PSOC
POLYCHLORINATED BIPHENYLS (TOTAL PCB)	39720	500	UG/L	1	1	every 3 years	waived	PSOC
SIMAZINE	39516	0.5	UG/L	0.5	0.5	every 3 years	waived	PSOC
THIOBENCARB	39055	4	UG/L	1	1	annually	every 9 years	PSOC
TOXAPHENE	A-001	70	UG/L	1	1	every 3 years	waived	PSOC
2,3,7,8-TCDD (DIOXIN)	39400	3	UG/L	1	1	every 3 years	waived	PSOC
2,4,5-TP (SILVEX)	34676	0.00003	UG/L	0.000005	0.000005	every 3 years	waived	PSOC
	39045	50	UG/L	1	1	every 3 years	waived	PSOC

Notes

- (a) For sources not exceeding the MCL or a trigger level. Contact the Riverside District Office regarding the monitoring requirements for sources that exceed the MCL or trigger level.
- (b) Trigger Level is Secondary MCL
- (c) Action Level, not MCL. Samples taken at tap (See CCR Title 22 Section 64678) or source water (See CCR Title 22 Sections 64685 and 64686)
- (d) Three Levels: Recommended, Upper, and Short Term (See CCR Title 22 Section 64449)
- (e) Radium-226 + Radium-228 Combined
- (f) Initial Monitoring Requirement: 2 samples collected 5 to 7 months apart; one sample must be collected between May 1 and September 30 (See CCR Title 22 Section 64432.3)
- (g) Initial Monitoring Requirement: 4 consecutive quarterly samples
- (h) Every quarter, or every 3, 6 or 9 years based on the initial monitoring results.
- (i) Monitoring for Uranium is required if Gross Alpha exceeds the Gross Alpha trigger; monitoring for Radium is required if (Gross Alpha minus Uranium) exceeds the Radium trigger
- (k) Excluding radon and uranium
- (m) Initial Monitoring Requirement: 4 consecutive quarterly samples. Contact the Riverside District Office after you receive the first sample results (See CCR Title 22 Section 64445).
- (n) Per the Department's August 22, 2001 letter to systems: Instead of monitoring for all SOC compounds at each well, systems >1,000 service connections can select representative wells (numbering at least 10% of total) for complete SOC monitoring, and be waived from monitoring most of the SOC compounds in the rest of the wells.

State of California
 Department of Public Health
 System Name: City of Oceanside

Drinking Water Field Operations Branch
 San Diego District

System Number: 3710014

Date: March 2009

Parameter	STORET	MCL	Units	DLR	Trigger	Monitoring Frequency (a)	
						Active Wells	Standby Wells

Definitions

- MCL Maximum Contaminant Level
- DLR Detection Limit, for the purposes of reporting
- Trigger The level at which a follow-up action may be taken, such increased monitoring. It is not necessarily a regulatory violation
- Waived Source is not required to be monitored for the compound, for various reasons including susceptibility, historical use, regulatory requirement, etc., for the compliance cycle
- Once Source must be monitored once for the compound, and pending negative results, are waived thereafter
- STORET Unique Identifier for each chemical or compound, used by laboratories for Electric Data Transfer reporting

California Code of Regulations, Title 22 (22 CCR)

- BAC Bacteriological
- PI Primary Inorganic Chemical (22 CCR 64431, Table 64431-A)
- PSOC Regulated Non-Volatile Synthetic Organic Chemicals (SOCs) (22 CCR 64444, Table 64444-A)
- PVOC Regulated Volatile Organic Chemicals (VOCs) (22 CCR 64444, Table 64444-A)
- RAD Radiological (22 CCR 64441 and 64443)
- SI Secondary Inorganic Chemicals (22 CCR 64449)
- U Unregulated Chemicals - (22 CCR 64450, Table 64450)

Attachment No. 6

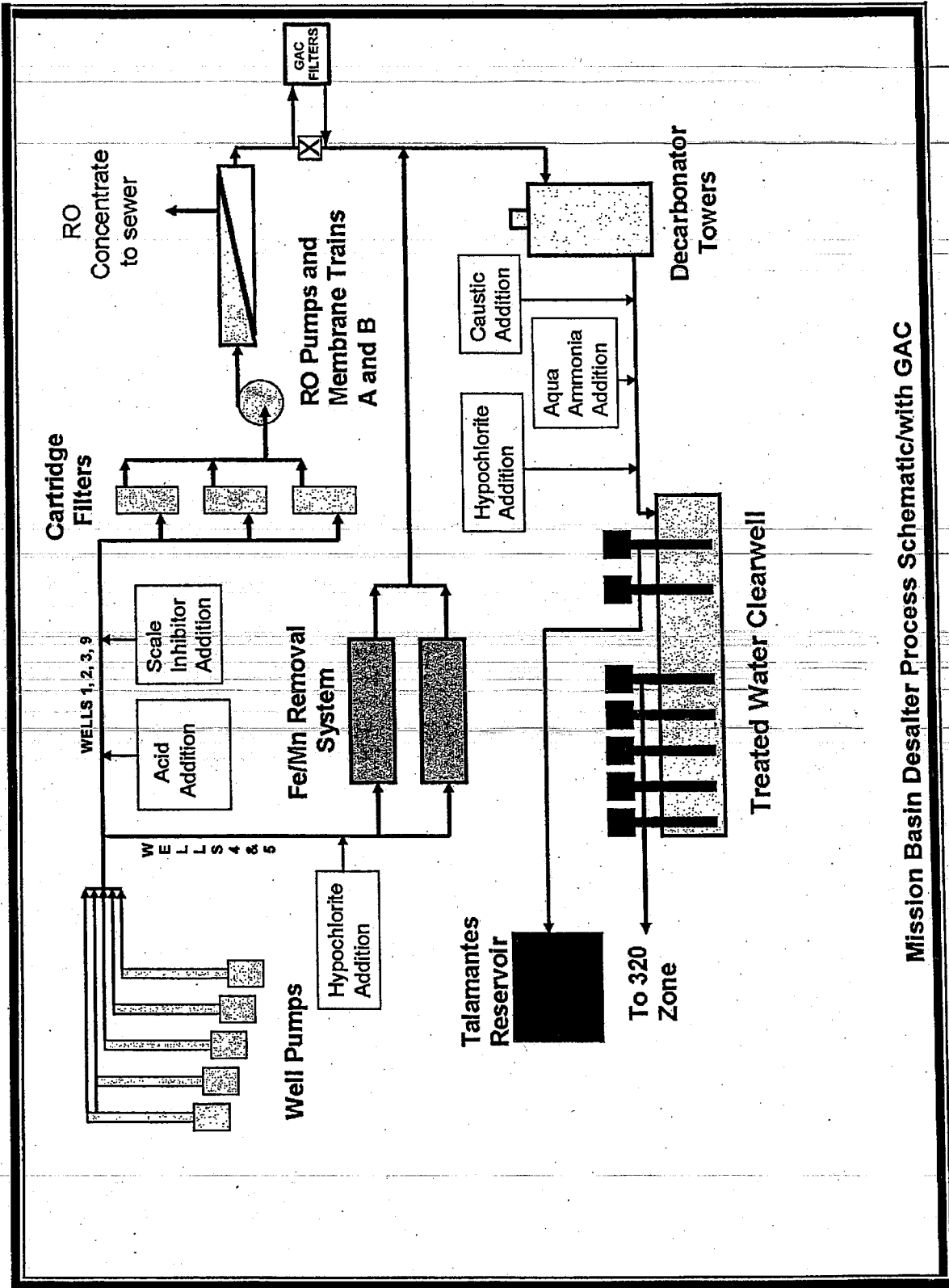

Mission Basin Desalter Process Schematic/with GAC

Attachment No. 7

1.2.3 TCP REDUCTION SYSTEM, PARALLEL
 (5) 12" DIA. HP1220S-SYS-125
 W/20,000 AC1230C CARBON/VESSEL
 LINED CARBON STEEL CONSTRUCTION

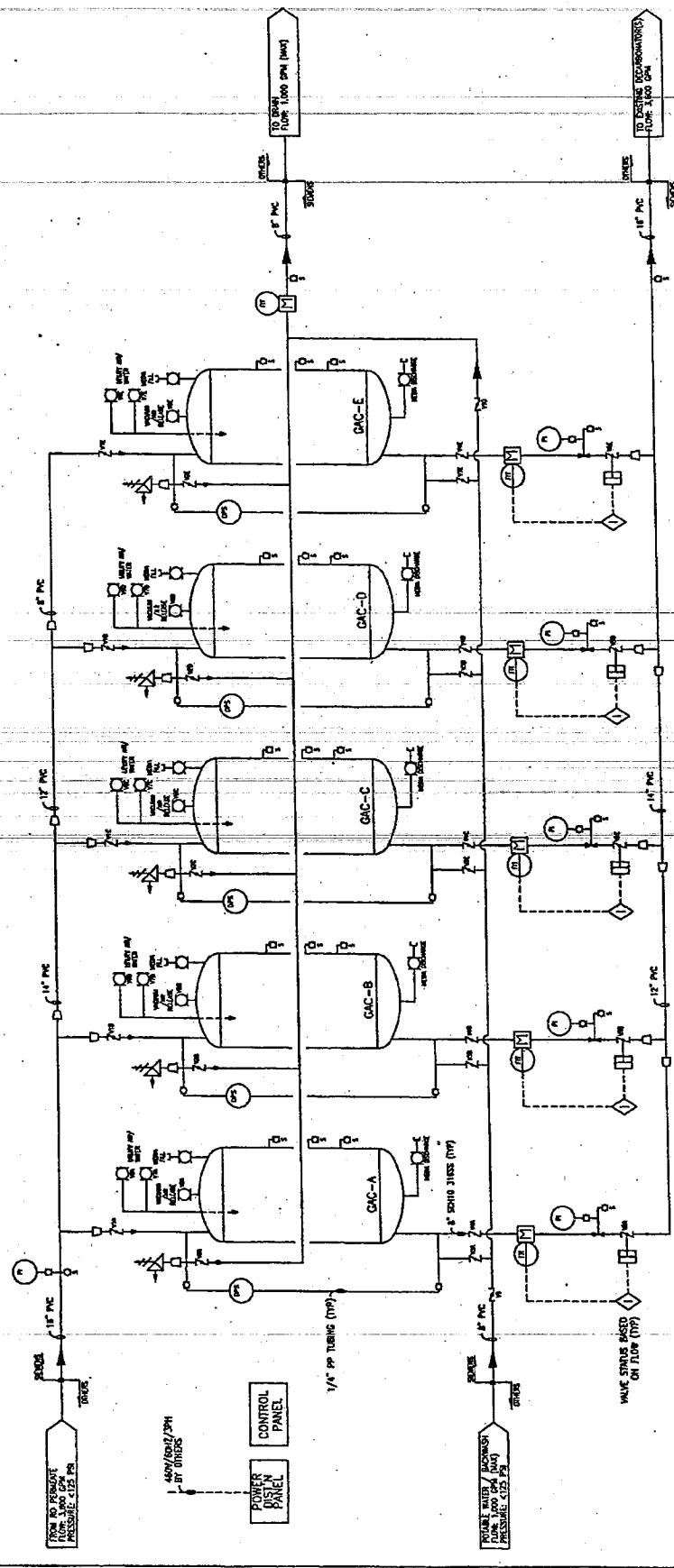

- NOTES:
1. CONCRETE PAD, FENCE AND SECURITY BY OTHERS (REFERENCE LAYOUT)
 2. FLANGED IN/OUT CONNECTIONS AT EQUIPMENT BOUNDARY BY OTHERS (REFERENCE LAYOUT)
 3. 480/600/570 PS POWER TO POWER DISTRIBUTION PANEL BY OTHERS
 4. 4-20mA OUTPUT WIRING FROM INSTRUMENTATION VESSEL TO BE SCHED 318SS
 5. PIPE BOUNDS OF BITEY VALVES TO BE SCHED 318SS
 6. OPERATION, PER SPEC. 4 ON LINE, 1 ON STANDBY

PRELIMINARY
 NOT FOR CONSTRUCTION

PROJECT NO.		1.2.3 TCP REDUCTION SYSTEM - AS BUILT	
CLIENT		MERCOR PROCESSING FACILITY	
DESIGNER		SIEMENS	
DATE		07/11/00-01	
DRAWN BY		J. G. 1	
CHECKED BY		J. G. 1	
APPROVED BY		J. G. 1	
SCALE		AS SHOWN	
SHEET NO.		1 OF 1	
PROJECT LOCATION		MERCOR PROCESSING FACILITY, OCEANVILLE, CA	
PROJECT NO.		710-321-0018	
DATE		7/11/00	
DRAWN BY		J. G. 1	
CHECKED BY		J. G. 1	
APPROVED BY		J. G. 1	
SCALE		AS SHOWN	
SHEET NO.		1 OF 1	

Attachment No. 8



California Department of Public Health
MEMORANDUM

DATE: January 8, 2009

TO: Bill DiBiase
CDPH San Diego District Office

FROM: Nancy Dagle
CDPH Environmental Review Unit

SUBJECT: WATER SUPPLY PERMIT FINDINGS FOR CITY OF OCEANSIDE, GRANULAR ACTIVATED CARBON SYSTEM AND WELL NO. 9, WATER SYSTEM ID 3710014

Following is the recommended environmental language for the permit findings:

The California Department of Public Health (CDPH) as Responsible agency pursuant to CEQA (California Environmental Quality Act) has reviewed the Worksheet for CEQA Exemptions prepared by the City of Oceanside on August 21, 2008. The CDPH found that the project did not require further environmental review. The City of Oceanside filed a Notice of Exemption through the County Clerks Office on August 19, 2008.

As a Responsible agency, CDPH has considered the Worksheet and project description and hereby makes the following findings for permit amendment:

The project is exempt from CEQA under CCR, Title 14

- Class 1 (CCR, Title 14, Sec 15301 and Title 22, Section 60101 (a))
- Class 2 (CCR, Title 14, Sec 15302 and Title 22, Section 60101 (b))
- Class 3 (CCR, Title 14, Sec 15303 and Title 22, Section 60101 (c))
- Class 4 (CCR, Title 14, Sec 15304 and Title 22, Section 60101 (d))
- Class 6 (CCR, Title 14, Sec 15306 and Title 22, Section 60101 (e))

There are no recommended permit conditions.

Attached is a proposed Notice of Exemption (NOE) that must be filed with the Governor's Office of Planning and Research.

Immediately following the issuance of the permit, please fill in the underlined blanks in the NOE and return it to the Environmental Review Unit.

Notice of Exemption
(Categorical)

To: Office of Planning and Research **From:** California Department of Public Health
P.O. Box 3044 GDPH San Diego District Office
Sacramento, CA 95812-3044 1350 Front Street
San Diego, CA 92101

Project Title: Granular Activated Carbon System and Well No. 9



City: Oceanside

County: San Diego

Description and Purpose of Project: Installation of a Granular Activated Carbon Treatment System (GAC) for removal of Trichloropropane (TCP) which will require the installation of a concrete foundation, miscellaneous piping and five GAC Contactor Vessels

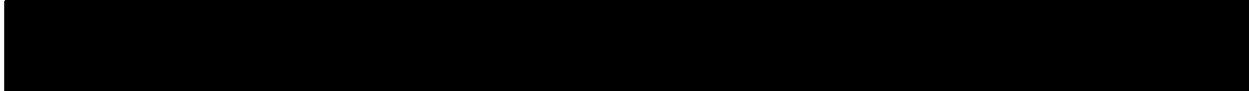

Public Agency Approving Project and Carrying out project: City of Oceanside, #3710014

Categorical Exemption Status:

- Class 1 (CCR, Title 14, Sec 15301 and Title 22, Section 60101 (a))
- Class 2 (CCR, Title 14, Sec 15302 and Title 22, Section 60101 (b))
- Class 3 (CCR, Title 14, Sec 15303 and Title 22, Section 60101 (c))
- Class 4 (CCR, Title 14, Sec 15304 and Title 22, Section 60101 (d))
- Class 6 (CCR, Title 14, Sec 15306 and Title 22, Section 60101 (e))

This is to advise that the California Department of Public Health has issued a water supply permit (permit number 05-14-09PA-010) for the above described project on March 23, 2009, and has determined that the project is exempt from the California Environmental Quality Act.

Contact Person:

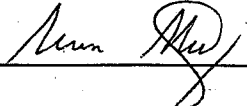
Signature  Date 3/23/09

Name: Sean Sterchi Title: DISTRICT ENGINEER Phone: (619)525-4922

Date received for filing with Governor's Office of Planning and Research: _____